

START.20.20

SMART DESIGN FOR YOUNG PEOPLE

CLEVER



CLEVER

START.20.20

SMART DESIGN FOR YOUNG PEOPLE





BENVENUTI NEL MONDO START.20.20

Il programma Start Clever evolve e si sviluppa con nuove idee e composizioni, nuove finiture materiche, colori laccati e melaminici: un'intera gamma coordinata di prodotti si rinnova e si amplia con l'obiettivo di creare un punto di riferimento nel design di qualità per la zona notte giovane.

Start.20.20 offre tutte le soluzioni per la zona notte: dalle più lineari con letti a terra alle più sofisticate e funzionali dei progetti salvaspazio con ponti, soppachi e letti a scomparsa.

Tutto questo in una vastissima gamma di finiture e materiali, melaminici, laccati e metallo, per esaudire ogni richiesta di stile e di funzionalità.

WELCOME TO THE WORLD START 20.20

The Start Clever program evolves and develops with new ideas and compositions, new materic finishes, lacquered and melamine colors: a whole range of products is renewed and expanded with the aim of creating a benchmark in quality design for the young night area.

Start.20.20 offers all sleeping solutions: from the most linear ground floor compositions to the most sophisticated and functional of space-saving projects with,bridges,loft beds and murphy beds.

All this with a huge assortment of finishes and materials, melamine, lacquered and metal, to meet ant demand for style and functionality.

Clever è da sempre attenta all'ambiente e alla salute delle persone, a cominciare dagli stabilimenti produttivi, tutti in Italia, che adottano i più alti standard europei per creare prodotti sicuri, pratici ed ecosostenibili che entreranno nelle case dei consumatori.

Test di qualità e di atossicità sono svolti su tutti i prodotti e materiali.

Ecopannelli certificati da coltivazioni rinnovabili, vernici ad acqua, imballaggi facilmente riciclabili.

Mobili progettati e realizzati in Italia, funzionalità, sostenibilità: sono questi i tre punti di forza di Start.20.20.

A QUALITY WORLD, FUNCTIONALITY AND DESIGN, CAREFUL FOR WELLNESS AND ENVIRONMENT.

Clever traditionally takes care to the environment and to the health of people, starting with manufacturing sites, all in Italy adopting the highest European standards to create safe, practical and eco-friendly products that will enter inside the consumer homes.

Quality and non-toxic testing are carried out on all products and materials. Ecopannels certified by renewable crops, water paints, easily recyclable packaging.

Furniture designed and made in Italy, functionality, sustainability: the three strengths of Start.20.20.

UN MONDO DI QUALITÀ, FUNZIONALITÀ E DESIGN.
E DI ATTENZIONE PER IL BENESSERE E L'AMBIENTE.

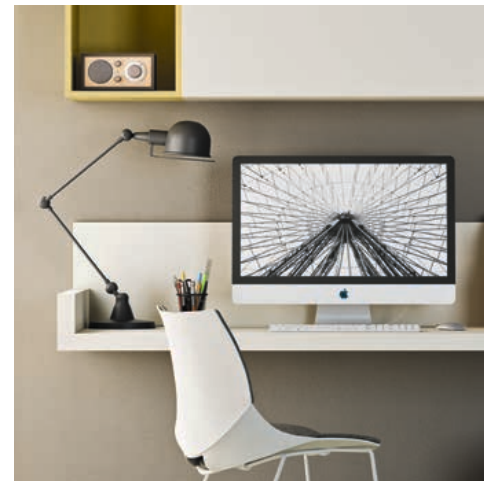



Tutti gli armadi e i mobili contenitori Start.20.20 possono essere scelti in due diverse finiture ed equipaggiamenti interni: "Sport" e "Prestige".

La qualità complessiva non cambia: ad esempio tutti i frontali di cassetti ed ante hanno spessore 22 mm e negli armadi ogni anta è sostenuta da 6 cerniere (nella versione H 2600 mm) per garantire la massima affidabilità e durata nel tempo.

Sport e Prestige: l'alto pregio su ogni prodotto con una possibilità di scelta e personalizzazione in più.

A QUALITY WORLD, FUNCTIONALITY AND DESIGN, CAREFUL FOR WELLNESS AND ENVIRONMENT.

All the wardrobes and storage cabinets **Start.20.20** can be chosen in two different finishes and internal equipments: "Sport" and "Prestige".

Overall quality does not change: for example all the drawers and doors frontals have 22 mm thick and the wardrobe doors have 6 hinges for each one (version H 2600 mm) to ensure maximum reliability and durability.

Sport and Prestige: the high value on each products with one more possibility of choice and personalization.

UN MONDO DI OPPORTUNITÀ E PERSONALIZZAZIONI CON GLI ALLESTIMENTI "SPORT" E "PRESTIGE"



EQUIPMENT "SPORT"

HANGING RODS IN METAL CHROMED

DOORS AND FRONTALS 22 MM TH.

WARDROBE DOORS WITH 6 HINGES

DRAWERS WITH SOFT CLOSING SYSTEM WITH ANTI NOISE AND SAVE-FINGERS

INTERNAL DRAWERS WOOD MADE WITH BASE 8 MM TH. IN MELAMINE TEXTURE FINISH

EQUIPMENT "PRESTIGE"

HANGING RODS IN METAL BURNISHED WITH NO-SLIP RUBBER

DOORS AND FRONTALS 22 MM TH.

WARDROBE DOORS WITH 6 SOFT CLOSING HINGES

DRAWERS WITH TOTAL EXTRACTION, SOFT CLOSING SYSTEM, ANTI NOISE AND SAVE-FINGERS

INTERNAL DRAWERS MADE WITH ALUMINIUM BURNISHED WITH BASE 16 MM TH. IN MELAMINE TEXTURE FINISH.

WARDROBE DOORS INCLUDING DUST PROTECTION

ALLESTIMENTO SPORT



APPENDIABITI IN METALLO CROMATO
CON TUBI APPENDIABITI ARROTONDATI

ANTE E FRONTALI DA 22 MM

ANTE ARMADIO CON 6 CERNIERE

CASSETTI AD ESTRAZIONE PARZIALE
AMMORTIZZATI IN CHIUSURA
ANTI RUMORE E ANTISCHIACCIANENTO DITA

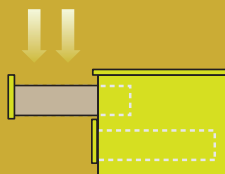

CASSETTI CON MECCANISMI IN METALLO
FIANCHI IN MELAMINICO TEXTURE
FONDO DA 8 MM IN MELAMINICO TEXTURE

ALLESTIMENTO PRESTIGE



APPENDIABITI IN METALLO BRUNITO
CON GOMMINI ANTISCIVOLAMENTO

ANTE E FRONTALI DA 22 MM

ANTE ARMADIO CON 6 CERNIERE
"MOTION" RALLENTATE IN CHIUSURA

ANTE ARMADIO CON
GUARNIZIONE ANTIPOLVERE

CASSETTI AD ESTRAZIONE TOTALE
AMMORTIZZATI IN CHIUSURA
ANTI RUMORE E ANTISCHIACCIANENTO DITA

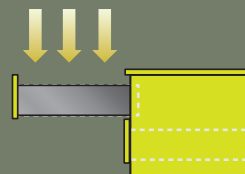

CASSETTI CON MECCANISMI IN ALLUMINIO
FIANCHI IN ALLUMINIO VERNICIATO BRUNITO
FONDO DA 16 MM IN MELAMINICO TEXTURE



COMPOSIZIONI CON LETTI A TERRA PAG 11

COMPOSIZIONI A PONTE PAG 143

COMPOSIZIONI SALVASPAZIO PAG 231

ABACO PRODOTTI PAG 303

LETTI A TERRA PAG 304

LETTI A CASTELLO PAG 332

SCRITTOI E CASELLARI PAG 336

COMODINI E CASSETTIERE PAG 348

MANIGLIE PAG 352

COLORI E MATERIALI PAG 359

ELENCO COMPOSIZIONI PAG 365

A dark, moody photograph of a window. A patterned curtain is visible through the window frame. The scene is dimly lit, with a focus on the textures of the curtain and the window frame. The text "START.20.20" is overlaid on the right side of the image.

START.20.20





Una composizione con letto a terra dinamica, fresca e accattivante. Caratterizzata dall'eleganza del colore Tortora e dell'essenza legno Noce Canaletto contrastati dalla vivacità del colore Miele laccato e del tessuto Rally 11.

I casellari in metallo Kios sono coordinati con lo scrittoio, con il letto e con le finiture della Cabina Naked.

Il letto Cale con testiera imbottita è corredato dal giroletto laccato Miele con gambe Kios e di materasso da 900 x 2000 mm.

Composition with floor standing bed, dynamic fresh and endearing. Characterized by the elegance of the color Tortora and by the wood finish Noce Canaletto, contrasted by the brightness of the Miele lacquered color and by the fabric Rally 11. Metal boxes Kios are matched with the desk, the bed and with the finishes of cabinet Naked.

The bed Cale with upholstered headboard included the ring lacquered Miele with legs Kios and mattress size 900 x 2000 mm.

S20_T01 :

CALE

Letto con testiera imbottita | Bed with upholstered headboard

KIOS

Gambe scrittoio e casellari | Desk legs and boxes

NAKED

Cabina armadio | Walk in closet



Tortora melaminico

Miele laccato

Noce Canaletto essenza

Acciaio brunito

Tessuto Rally TA11





S20_T01

Cabina Naked con ripiani e cassetti. Letto Cale con testiera imbottita, rete da 900 x 1950 mm e gambe Kios. Casellari in metallo Kios. Scrivitoio spess. 50 mm con gambe Kios.

Closet Naked with shelves and drawers. Bed Cale with upholstered headboard, base 900 x 1950 mm on legs Kios. Metal boxes Kios. Desk th.50 mm on legs Kios.

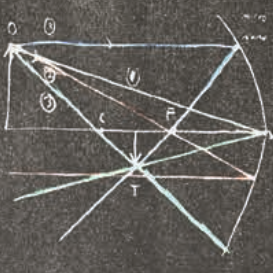

A built-in wardrobe system against a dark charcoal wall. It features light wood shelves and hanging clothes. The wardrobe includes a wooden cabinet, a yellow shelf with shoes, and a yellow shelf with a tennis racket. The hanging clothes include shirts, blouses, and a jacket. There are also some folded clothes on the shelves and a basket of sticks on top.



Dettaglio della zona studio: scrittoio con gambe in metallo Kios in appoggio alla cassettera. Casellario Kios in metallo brunito con ripiani color Miele.

Deetail of study area: desk with metal legs Kios resting on box base. Box Kios burnish metal with shelves lacquered Miele.

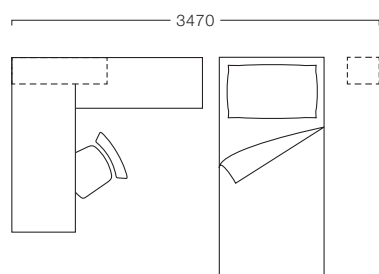

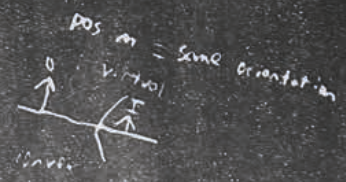
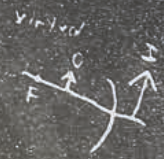
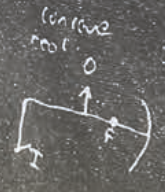

THINK
OUTSIDE
THE BOX



Naked è un sistema completo per arredare cabine armadio o per creare zone contenitive "a vista". Le finiture metalliche sono in colore brunito, i ripiani e i frontali di cassettiere e accessori possono essere in melaminico, laccati o in essenza legno. Molti accessori modulari sono disponibili per creare la migliore soluzione personalizzata.

Naked is a complete system for furnishing cabinets or to create "visual" containment areas. The metallic finishes are burnished color, the shelves and the fronts of drawer and accessories can be in melamine, lacquered or wood essence. Many modular accessories are available to create the best personalized solution.

CABINA NAKED

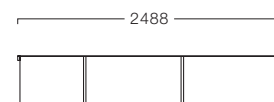

Cabina Naked con ripiani e cassetti.
Finiture: Tortora, Noce canaletto, Miele.

*Closet Naked with shelves and drawers.
Finishes: Tortora, Noce Canaletto, Miele.*





Il divano letto Apollo con materasso da 900 mm è il cuore di questa funzionale composizione con armadio battente con ante lisce e maniglia Sigma C15, ante a telaio alluminio brunito e vetri fumé. Ambrogio è il nome dell'originale e pratico appendiabiti esterno su panca affiancato all'armadio.

Lo Scrittoio spess. 50 mm con gambe Kios in appoggio sulla base con cassetti e i casellari a giorno Kios in metallo brunito completano con raffinatezza l'insieme.

The Apollo sofa with 900 mm mattress is the heart of this functional cabinet with smooth front doors and Sigma C15 handle, burnished aluminium frame doors and smoked glasses. Ambrogio is the name of the original and practical outer coat rack on the bench beside the closet.

The desk is thick. 50 mm with Kios legs on the base with drawers and burnished metal Kios boxes complete the refinement of the set.

S20_T02 :

APOLLO

Divano letto | Sofa bed

KIOS

Gambe scrittoio e casellari | Desk legs and boxes

DUPLO

"Angolo armadio" ad anta battente | Hinged door wardrobe



Tortora melaminico

Cemento Bianco melaminico

Rame laccato

Antracite laccato

Metallo brunito



Another
Art
Book



S20_T02

Appendiabiti Ambrogio su panca. Armadio battente con maniglia Sigma C15.
Armadio battente con ante vetro telaio brunito, vetro fumé. Armadio Duplo.
Divano-letto Apollo rete 900. Scrivitoio spess. 50 mm con gambe Kios in metallo
brunito. Base con cassetti. Casellari Kios in metallo brunito.

Ambrogio external clothes hanger on bench. Wardrobe with handle Sigma C15.
Wardrobe with glass doors and burnished frame, Fumé glass. Wardrobe Duplo.
Sofa bed Apollo with base 900. Desk th.50 mm with legs Kios in burnished metal
Box base with drawers. Boxes Kios in burnished metal.



Dettaglio della zona studio: scrittoio con gambe in metallo Kios in appoggio alla cassettera. Casellario Kios in metallo brunito con ripiani laccati color Rame.

Deetail of study area: desk with metal legs Kios resting on box base, Metal burnished Box Kios with shelves lacquered Rame.

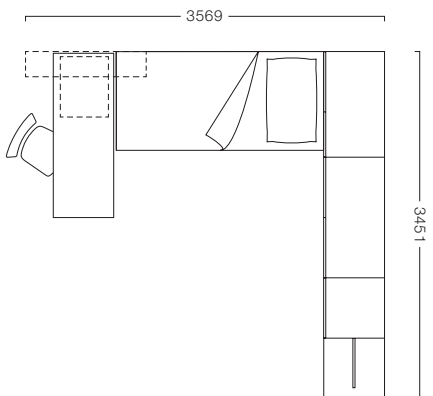









Una sofisticata composizione caratterizzata dal letto Fresh da una piazza e mezza, laccato e con inserto in Noce Canaletto. L'ampia zona contenimento è formata dall'armadio battente con maniglia Stripe integrato con la cabina Flexy a spalla doppia profondità, dotata di ripiani e settimanale.

I casellari in metallo Kios a muro e sovrapposti alle basi a terra con cassetti in Noce Canaletto completano l'arredamento con elegante minimalismo, insieme alle geometrie delle mensole Star ad ali di gabbiano.

A sophisticated composition featuring from the Fresh bed with one and half size, lacquered and with insert in Canaletto Walnut. The large enclosure area is formed by the hinged wardrobe door with Stripe handle integrated with the Flexy double depth cabin, equipped with shelves and chest of drawers. The Kios metal wallcases and overlapping bases with drawers in Noce Canaletto complete the furnishing with elegant minimalism, along with the geometries of the Star shelves with seafull wings shape.

S20_T03 :

FRESH

Letto con cornici in legno laccato | Bed with wooden frame lacquered

FLEXY

Cabina a spalla doppia profondità | Cabin with double depth

KIOS

Casellari metallici a giorno | Metallic wallboxes

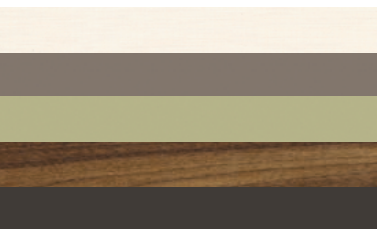

Neve melaminico

Terra laccato

Malva laccato

Noce Canaletto essenza

Metallo brunito





S20_T03

Armadio battente con maniglia Stripe. Cabina Flexy senza schiena con ripiani e settimanale. Letto Fresh rete 1200 mm. Basi a terra con cassetti e casellari in metallo Kios in appoggio. Mensele Star.

Wardrobe with handle Stripe. Cabine Flexy without back with shelves and chest of drawers. Bed Fresh with base 1200. Floorstanding boxes with drawers and Kios metal boxes resting on. Shelves Star.







KIOS

Casellari a muro in metallo brunito.
Basi con cassetti push-pull
con frontali in essenza legno
noce canaletto.

Wallboxes in metal burnished.
Bases with drawers push-pull opening
with fronts Noce Canaletto essence.

La cabina Flexy è affiancata all'armadio battente con maniglia Stripe creando un originale spazio per il contenimento.

Cabina e armadio sono presentati nella versione "Prestige": appenderia in metallo brunito dal design squadrato con gommini antidrucciolo, ante con rallentatore e parapolvere, cassettiere ad estrazione totale con interni in alluminio finitura Brunito e chiusura rallentata.

The Flexy cabin is side-by-side to the wardrobe with Stripe handle, creating an original space for containment.

Cabin and wardrobe are presented in the "Prestige" version: squared metal hangers with anti-slip rubber, soft closing and dust-proof doors, drawer units with aluminium burnished finish, soft closing and total extraction.

CABINA FLEXY + ARMADIO BATTENTE

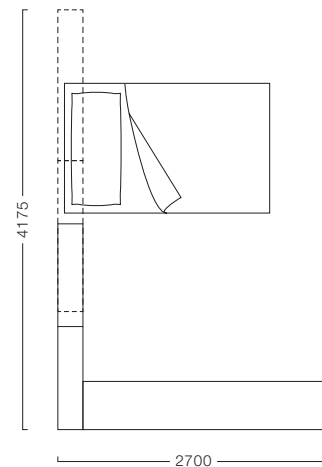
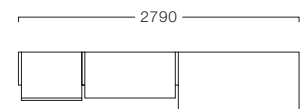







STAR

Mensola sagomata

Shaped shelf





XL SYSTEM





XL è un innovativo sistema modulare di letti con cassettoni estraibili dal design minimale e squadrato, ideali per chi vuole vivere appieno lo spazio anche di giorno, grazie anche alle pannellature imbottite Cloud applicabili a piacere. La zona studio è creata dallo scrittoio con piano da 50 mm con gamba Kios, e i casellari Kios a muro.

Completa la composizione l'ampia zona contenimento formata dall'armadio a ponte autoportante insieme alla cabina Naked.

XL is an innovative modular bedding system with removable drawers with minimal and squared design, ideal for those who want to fully enjoy the space even in the daytime, thanks to the padded panels applicable according your tastes. The study area is created by a desk with a 50 mm th. with Kios leg and Kios wallcases. Complete the composition the large containment area formed by the self-supporting bridge along with the Naked cabin.

S20_T04 :

XL SYSTEM

Letto contenitore a cassettoni | Bed with storage and drawers

PONTE BLOK

Armadio autoportante | Self-supporting wardrobe

CLOUD

Pannellature imbottite | Upholstered panels



Olmo Cenere melaminico

Tortora melaminico

Terra laccato

Cielo melaminico

Tessuto Rally TA12-TA13



XL SYSTEM

Programma modulare di letti contenitori con cassettoni totalmente estraibili.

Modular bedding system with drawers totally removable.



S20_T04

Armadio battente con maniglia Ghost. Ponte autoportante con maniglia Ghost.
Cabina Naked brunita con ripiani e cassettiere appese. Letto XL con pannellatura
Cloud. Scrivania spess. 50 mm con gamba Kios brunita. Casellari in metallo Kios.

Wardrobe with handle Ghost. Self-supporting bridge with handle Ghost.
Cabin Naked burnished with shelves and hanging chest of drawers. Bed XL with
panels Cloud. Desk th. 50 mm with burnished leg Kios metal boxes Kios.



Armadio battente con maniglia Ghost e Ponte autoportante con maniglia Ghost integrati con la Cabina Naked brunita con ripiani e cassettiere appese.

Letto XL con pannellatura Cloud, scrittoio spess. 50 mm con gamba Kios brunita, casellari in metallo brunito Kios.

Finiture: Olmo Cenere, Tortora, Terra, Avio, Tessuto TA12-TA13.

Hinged door wardrobe with Ghost handle and self-supporting bridge with Ghost handle integrated with the cabin Naked burnished with hanging shelves and drawers.

XL bed with Cloud paneling, desk th.50 mm with Kios burnished leg, Kios burnished metal wallboxes.

Finishes: Olmo Cenere, Tortora, Terra, Avio; TA12-TA13 fabric.

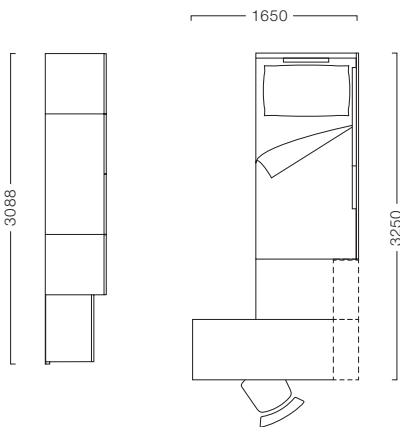



Gli elementi della cabina Naked si integrano con le modularità dell'armadio battente e il ponte autoportante Blok con maniglie Ghost, creando una soluzione originale e innovativa con spazi chiusi e aperti, cassettiere sospese e pratici ripiani a giorno spostabili a piacere.

The elements of the Naked cabin are complemented by the modularity of the wardrobe and the self-supporting Blok bridge with Ghost handles, creating an original and innovative solution with enclosed spaces and views, suspended drawers and practical removable shelves.

PONTE BLOK E CABINA NAKED











I letti XL System, con la grande modularità compositiva risolvono ogni situazione e ogni spazio. Sono sempre dotati di 2 cassettoni su ruote completamente estraibili. Il materasso poggia direttamente sul pianale della base con cassettoni dotato di fori di aerazione.

Con i pannelli imbottiti Cloud è possibile creare originali composizioni per la testiera del letto.

XL System beds, with great compositional modularity, solve every situation and space. They are always equipped with 2 drawers on wheels totally removable. The mattress rests directly on the floor of the base with drawers equipped with ventilation holes. With Cloud padded panels you can create original compositions for the bed headboard.

S20_T05 :

XL SYSTEM

Letto contenitore a cassettoni bifacciali | Bed with double-face storage drawers

CLOUD

Pannelli imbottiti multiuso | Padded panels multipurpose

MAXI

Armadio battente con maniglia Stripe | Hinged door wardrobe with handle Stripe



Olmo Chiaro melaminico

Tortora melaminico

Ciclamino laccato

Antico laccato

Tessuto Rally TA14-TA03





S20_T05

Armadio battente Maxi con maniglia Stripe e libreria terminale con scrittoio a ribalta. Letto XL con pannellatura imbottita Cloud. Mensole Star. Settimanile su panca con appendiabiti in metallo Ambrogio.

Wardrobe with hinged door Maxi with handle Stripe and terminal bookcase and flap desk. Bed XL with padded panels Cloud. Shelves Star. Chest of drawers on bench with metal clothes rack Ambrogio.



ARMADIO MAXI E SCRITTOIO

L'armadio Maxi è in pratica una cabina con profondità 1050 mm che consente il doppio tubo appendiabiti e di accessoriare gli interni per il massimo contenimento.

La libreria terminale è dotata di scrittoio reclinabile a scomparsa con meccanismi servoassistiti per l'apertura e la chiusura. Una soluzione originale e funzionale per avere uno scrittoio anche in poco spazio e per avere la stanza sempre in ordine.

The Maxi wardrobe is basically a cabin with a depth of 1050 mm which allows the double hanger rods and accessories for the interior for maximum containment.

The terminal library is equipped with retractable reclining desk with servo assisting mechanisms for opening and closing. An original and functional solution to have a writing desk even in small space and to keep the room settled.

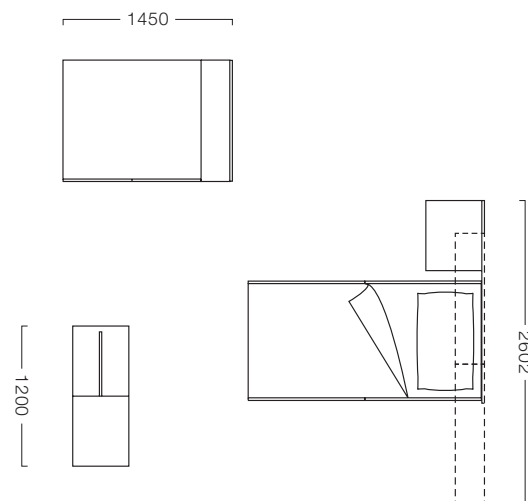



XL SYSTEM







Atmosfera metropolitana e disinvolta creata con le superfici materiche dei nuovi "Cemento Bianco" e "Cemento Grigio" dell'armadio e della zona studio, insieme al colore fashion Laguna laccato negli inserti delle ante dell'armadio. Una precisa scelta di stile sottolineata dal design accogliente del letto Doll da una piazza e mezza rivestito con tessuto caldo e neutro.

A subtle and relaxed atmosphere created with the surface of the new "Cemento Bianco" and "Cemento Grigio" of the closet and study area, along with the Laguna lacquered color in the cabinet door inserts. A distinct style emphasized by the cozy design of the Doll bed with one and half size coated with warm and neutral fabrics.

S20_T06 :

DOLL

Letto imbottito piazza e mezza | Upholstered bed one and half size

STRIPE

Ante armadio bicolor | Doors wardrobe bicolored

BLOK

Armadio-ponte autoportante | Self-supporting bridge wardrobe



Platino melaminico

Cemento Bianco melaminico

Cemento Grigio melaminico

Laguna laccato

Tessuto Rally TA12



Due esclusive superfici melaminiche per ante, frontali di cassetti, fianchi, pannelli decorativi ed anche nello spessore da 50 mm per top e piani di scrittoio. La finitura è opaca con un leggero rilievo piacevole al tatto, facilmente lavabile senza nessun particolare accorgimento.

Two exclusive melamine surfaces for doors, fronts of drawers, sides, decorative panels and even in the 50 mm thick for top and writing desks. The finish is matt with a slight touch pad, easily washable without any special attention.

CEMENTO GRIGIO CEMENTO BIANCO





Armadio battente con anta Stripe bicolor.
Ponte autoportante con ante Stripe bicolor.
Scrivania spess. 50 mm in appoggio a
libreria spalla e base a terra.
Letto Doll imbottito rete 1200 mm.

Finiture: Platino, Cemento Bianco, Cemento
Grigio, Laguna, Tessuto TA12.

Wardrobe with door Stripe bicolored.
Self-supporting bridge with doors Stripe
bicolored. Desk th.50 mm resting on
a library and floorstanding box base.
Upholstered Doll bed for base 1200 mm.

Finishes: Platino, Cemento Bianco, Cemento
Grigio, Laguna lacquered, TA12 fabric.

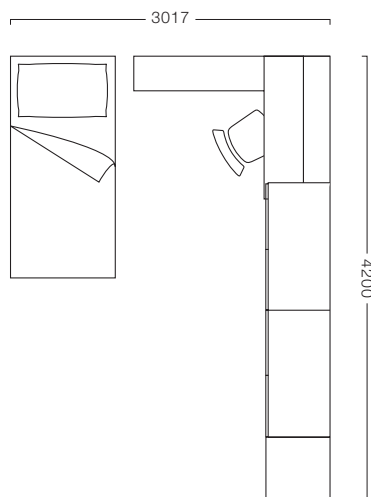



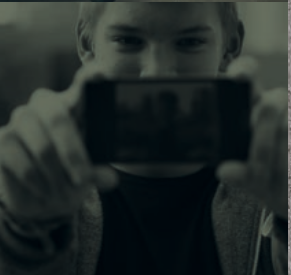





Il letto imbottito è il principe della zona notte: comodo, soffice, elegante. E quando il design minimale e lineare viene applicato in un letto imbottito ecco che nasce Slitta: un'unica linea sinuosa che accoglie e invita al relax.

Slitta è completamente sfoderabile: nelle immagini di queste pagine è presentato con il tessuto Malvasia lavabile in acqua a 30 gradi.

La composizione è completata con grande originalità anche nella zona studio e dall'armadio con appenderia a vista, specchio e terminale libreria.

The padded bed is the prince of the sleeping area: comfortable, soft, elegant. And when the minimal and linear design is applied in a padded bed, here is Slitta: a single sinuous line that welcomes and invites relaxation

Slitta is completely removable: in the pictures of these pages is presented with Malvasia fabric washable in water at 30 degrees

The composition is completed with great originality also in the study area and the closet with display hanging, mirror and bookcase terminal.

S20_T07 :

SLITTA

Letto imbottito piazza e mezza | Upholstered bed one and half size

STRIPE

Maniglie armadio a tutta altezza | Full height handles

FEDRA

Casellari soprapensili | Wall boxes

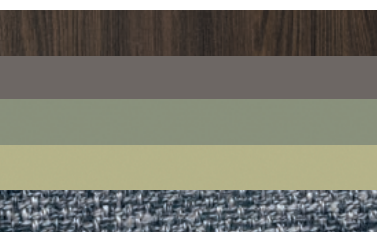

Olmo Scuro melaminico

Platino melaminico

Laguna laccato

Malva laccato

Tessuto Malvasia TB15





tion in Form

teNeues

Deutscher

Carsten Egevang

ANTIOQUAIRES
Detail in Contemporary Residential Architecture
Virginia McLeod
ALEXEY BRODOVITCH
NEW URBAN HOUSING
HARRY FRENCH
Gardens in France
LOST FISH
MAKING IT

ANTIOQUAIRES
Detail in Contemporary Residential Architecture
Virginia McLeod
ALEXEY BRODOVITCH
NEW URBAN HOUSING
HARRY FRENCH
Gardens in France
LOST FISH
MAKING IT



S20_T07

Armadio battente con maniglia Stripe, armadio con vano a giorno, specchio e appendiabiti, libreria terminale. Letto Slitta imbottito con rete 1200. Scrivitoio spess. 50 mm con gamba Slitta. Pensili apertura ribalta con casellari Fedra.

Wardrobe with hinged doors, handle Stripe, wardrobe with open space, mirror and hanging rods. Terminal bookcase. Upholstered bed Slitta with base w. 1200. Desk th. 50 mm with leg Slitta. Boxes with flap opening and boxes Fedra.

Originalità sotto ogni aspetto per uno spazio da vivere di giorno e di notte con tutto sempre a portata di mano.

I pensili con apertura push-pull sono "circondati" dagli originali ed esclusivi casellari "Fedra". Lo scrittoio con gamba a slitta e cassetto termina con il fianco e pedana che sostengono la cassettiera-comodino.

L'armadio con ante battenti esce dall'ordinario e diventa un oggetto d'arredamento grazie alla libreria, alla zona appendiabiti a giorno e ai segni grafici delle maniglie stripe a tutta altezza.

Originality in every respect for a living space of day and night with everything always handy

Push-pull hanging boxes are surrounded by the original and exclusive "Fedra" wallboxes. The desk with Slitta leg and drawer end with the side and the bench supporting the bedside chest of drawers.

The wardrobe with folding doors comes out of the ordinary and becomes a decorative object thanks to the bookcase, the hanger area and the graphic signs of the full-length Stripe handles.

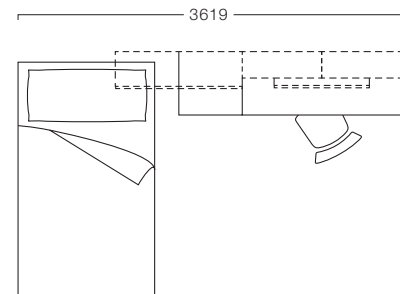







FEDRA

Casellario soprapensile

Wall box



Composizione solare e fresca grazie ai toni caldi e leggeri dell'Olmo Chiaro, del Perla laccato e del nuovissimo Cielo melaminico. Un accostamento armonico di colori che vive nel letto Terry, nell'armadio nei pensili e la zona studio.

Il design minimale e lineare può essere anche raffinato ed elegante come in questa composizione, allegra e molto funzionale.

Solar and fresh composition thanks to the warm and light tones of Olmo Chiaro, lacquered Perla and the new melamine Cielo. A harmonious approach of colors that lives in the Terry bed, in the cabinet, in the hanging boxes and study area.

The minimal and linear design can also be refined and elegant as in the composition, cheerful and very functional.

S20_T08 :

TERRY

Letto con gambe Quadro | Bed with Quadro legs

STAR

Mensole sagomate | Shaped shelves

DUO

Armadio con ante scorrevoli | Wardrobe with sliding doors



Olmo Chiaro melaminico

Perla laccato

Cielo melaminico





S20_T08

Armadio scorrevole Duo. Letto Terry con rete 900.
Basi a terra uso comodino con maniglia C03.
Pensili apertura a ribalta e battente, raccordati da mensola Star.

Wardrobe with sliding doors Duo. Bed Terry with base w. 900.
Floorstanding boxes for nightstand use with handle C03.
Hanging boxes with flap and hinged opening, connected with shelf Star.



Lineare, semplice e minimale: è l'armadio con le ante scorrevoli Duo da 1200 mm. In questa versione l'accostamento del laccato Perla con i toni caldi dell'Olmo Chiaro creano un look raffinato ed elegante, che continua negli interni sempre in Olmo Chiaro.

Linear, simple and minimal: it is the cabinet with sliding doors 1200 mm Duo. In this version, the approach of the lacquered Perla with the warm tones of Olmo Chiaro creates a refined and elegant look that continues in the interior in Olmo Chiaro.

ARMADIO DUO

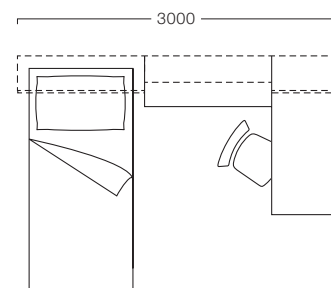
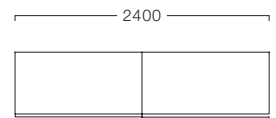



La dotazione "Prestige" è disponibile non solo negli armadi ma in tutti i mobili e cassettiere Start.20.20. le strutture dei cassetti Prestige sono realizzati completamente in alluminio, con meccanismo ad estrazione totale, servofreno in chiusura antischacciamento dita, fianchi in alluminio verniciato brunito e fondo in melaminico texture da 16 mm.

Nelle immagini di queste pagine dettaglio delle cassettiere in melaminico Cielo con cassetti Prestige e maniglie C03.

The "Prestige" equipment is available not only in the cabinets but in all the furniture and drawers Start.20.20. The Prestige drawers are made entirely of aluminium, with a total extraction mechanism, a save-fingers and soft-closing system, aluminium painted sides and melamine bottom 16 mm texture.

In the pictures of these pages detail of melamine chest of drawers in melamine Cielo with Prestige drawers and handles C03.



Basi a terra uso comodino con maniglia C03, con guide cassetto in metallo verniciato titanio. Pensili apertura a ribalta e battente, raccordati da mensola Star.

Floor standing boxes for bedside use with handle C03,with drawer guides, lacquered sides in burnished aluminium. Hanging boxes with flap and hinged opening, joined by Star shelves.









Archè: il letto dal design moderno e attuale ma non freddo e spigoloso, caratterizzato dalle smussature della testiera trapezoidale con spessore 50 mm. Archè può essere scelto con testiera laccata, giroletto e piedino quadro laccato e con ruote come in queste immagini ma è disponibile in 5 altre diverse configurazioni di giroletto e piedini oppure in versione con testiera imbottita.

La composizione S20_T09 è una soluzione integrata armadio-ponte, zona studio, letto comodo e librerie a giorno, disposti in modo lineare lungo una unica parete, perfetta quindi anche nelle situazioni di spazio ristretto.

Archè: the bed of modern and contemporary design but not cold and sharp, characterized by the bevels of the 50 mm thick trapezoidal headboard. Archè can be chosen with lacquered headboard, bedframe, leg and wheels as in these pictures but is available in 5 other different legs and bedframe configurations or with padded headboard.

Composition S20_T09 is an integrated cabinet-bridge solution, study area, bedside, bed and daytime bookcase, arranged linearly along a single wall, so perfect even in tight space situations.

S20_T09:

ARCHÈ

Letto con ruote | Bed with castors

SLIM GHOST

Ante armadi con gola | Doors with gola handle

GATE

Programma librerie | Bookshelf collection



Olmo Sbiancato melaminico

Beige melaminico

Antico laccato

Oceano laccato



Armadio battente con anta Slim Ghost.
Ponte autoportante con anta Slim Ghost.
Letto Arche' con ruote, rete da 900 mm.
Scrivania e panca in spess. 50 mm.
Libreria Gate H. 368 mm.

Finiture: Olmo Sbiancato melaminico, Beige melaminico, Antico laccato, Oceano laccato.

Wardrobe with hinged doors Slim Ghost.
Self-supporting bridge with door Slim Ghost.
Bed Archè on wheels with base 900.
Desk and bench th. 50 mm.
Bookcase Gate h.368 mm.

Finishes: Olmo Sbiancato and Beige melamine, Antico and Oceano laquered.

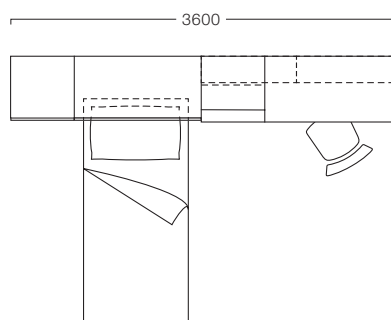



Ghost è il nome del sistema di maniglie a gola per ante e cassetti. Le maniglie Ghost sono integrate con l'anta o con il cassetto e diventano quindi un corpo unico, con lo stesso tinta laccata oppure in contrasto per creare superfici armoniche con modulazioni di chiaroscuro oppure con segni grafici colorati che personalizzano la composizione.

THE DOOR SLIM GHOST.

Ghost is the name of the system of groove handles for doors and drawers. The Ghost handles are integrated with the door or drawer and thus become a single body with the same lacquered or contrasting color to create harmonic surfaces with light and dark modulation or with colorful graphic signs that customize the composition.

L'ANTA SLIM GHOST

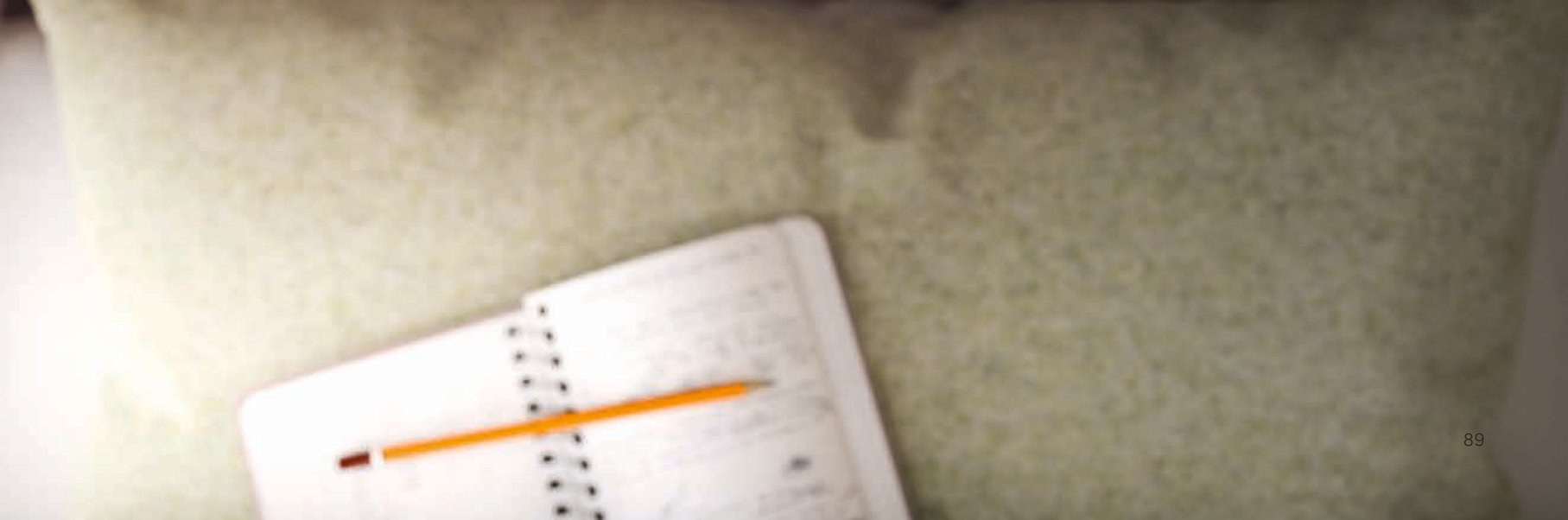
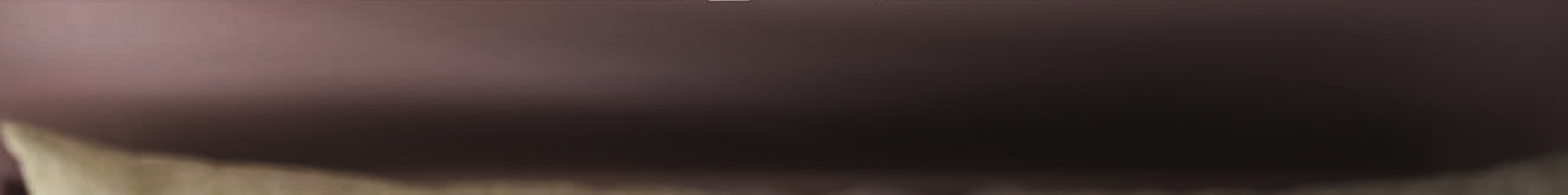







Se la zona studio è una priorità, o si vuole arredare il locale in stile home-office ecco che la soluzione ideale sono le librerie modulari Gate. Originali, funzionali e altamente decorative, sono disponibili in diverse misure e disposizioni, possono essere accostate tra loro per formare composizioni originali, grazie anche alla possibilità di scegliere la versione bicolore con gli schienali in contrasto. Il grande scrittoio sospeso (150 cm) completa la parete con la zona studio.

Il letto Karta con testiera imbottita, la capiente Cabina Angolo Lite, e le originali mensole sagomate Snake da 50 mm creano un insieme armonico e funzionale.

If the study area is a priority, or you want to furnish the home-office space, then, the Gate modular libraries are the ideal solution. Original, functional and highly decorative, are available in different sizes and arrangements, they can be combined to form original compositions, thanks to the choice of two-color version with contrasting backrests. The large suspended desk (150 cm) completes the wall with the study area.

The Karta bed with padded headboard, the large corner cabin Lite and the original 50 mm Snake shaped shelves create a harmonious and functional set.

S20_T10 :

GATE

Programma librerie | Bookshelf collection

KARTA

Letto con testiera imbottita | Bed with upholstered headboard

LITE

Cabina armadio angolo | Walk-in closet



Neve melaminico

Tortora melaminico

Verde melaminico

Muschio laccato

Tessuto Alice TA35





S20_T10

Cabina Lite con maniglia Tender C05 brunita. Letto Karta con testiera imbottita
Tessuto TA35. Mensole Snake. Scrivitoio sospeso spess. 50 mm.
Libreria Gate H. 1104-368. Cassettiera su ruote con maniglia Tender C04 brunita.

Corner cabinet Lite with burnished handle C05 bed Karta with upholstered
headboard TA35 fabric. Shelves Snake suspended desk th. 50 mm.
Library Gate h. 1104-368 chest of drawers on wheels with burnished handle C04.



Esternamente sembra un normale armadio, ed occupa lo stesso spazio della testiera del letto, ma internamente offre grandi possibilità di contenimento, con mensole, appenderie, cassettiere da scegliere e disporre in base alle proprie necessità.

THE LITE CABIN

External it looks like a normal wardrobe and occupies the same bed headboard space, but internally offers great possibilities of containment, with shelves, hangers, drawers to choose according to their needs.

CABINA LITE

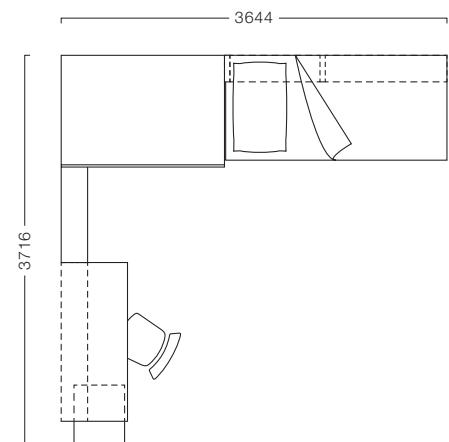



Dettaglio dell'anta della Cabina Lite in melaminico Neve (superficie effetto "tela") con Maniglia Tender C05 in metallo brunito.

Nella foto in basso dettaglio della cassettera su ruote con allestimento Prestige e maniglia Tender C04 in metallo brunito.

Detail of the cabin Lite with melamine Neve finish (surface effect "texture") with handle Tender C05 in burnished metal.

In the picture below, detail of the chest of drawers on wheels with Prestige trim and Tender C04 handle in burnished metal.

MANIGLIE TENDER







Bellissimo nella sua semplicità, il letto Karta è disponibile in diverse versioni, sempre con spessore di 50 mm della testiera, del pianale e dei supporti. La versione di Karta presentato in queste pagine ha la particolare configurazione "sospesa" che oltre a definirne l'originale design consente di "scivolare" su panchette e cassettiere che fanno da basamento e comodino.

Anche lo scrittoio scorre, aggangiato al binario dell'armadio-ponte Blok, per creare più spazio nei momenti di studio.

Beautiful in its simplicity, the Karta bed is available in different versions, always with a thickness of 50 mm on the headboard, the platform and the supports. The Karta version presented on these pages has the particular "suspended" configuration, that, as well as define the original design allows you to "slip" on benches and drawer units that stand as a base and nightstand.

The desk also slides, fasten on the rail of the bridge cabinet Blok, to create more space in the study moments.

S20_T11:

KARTA

Letto scorrevole | Sliding bed

BLOK

Armadio Ponte autoportante | Overhead unit

ARMADIO

Battente con terminale libreria | Hinged door with open end unit



Olmo Cenere melaminico

Tortora melaminico

Ocra laccato



CASE DA ABITARE

CASE DA ABITARE



S20_T11

Terminale libreria. Armadio battente con maniglia C11. Ponte autoportante Blok. Scrivitoio scorrevole spess. 30 mm con gambe Diapason. Panca con cassetiera in appoggio. Letto Karta scorrevole.

Open end unit. Wardrobe with handle C11. Overhead unit Blok. Sliding desk th. 30 mm with legs Diapason. Bench with chest of drawers overlapped. Sliding bed Karta.



L'armadio ad angolo è una soluzione salvaspazio tra le più efficaci e pratiche. Grazie alle ante dotate di cerniere con apertura a 180° l'accesso ai vani interni è facile come essere in una cabina armadio, le soluzioni di personalizzazione con vani, cassetti ed appenderie, anche con servetto estraibile, è vastissima.

The corner closet is a space-saving solution between the most effective and practical. Thanks to the doors with hinges 180° opening, access to the inside compartments is as easy as being in a closet, customization solutions with compartments, drawers and hangers, even with pull-out hanger, are vast.

ARMADIO AD ANGOLO





Non sempre lo spazio nella stanza è sufficiente per tutto ciò che desideriamo avere: grandi capacità di contenimento, una libreria, una grande zona studio e un comodo letto. Con lo scrittoio scorrevole si risolve il problema dello spazio con intelligente funzionalità.

SLIDING DESK

Not always space in the room is enough for everything we want to have: great containment capacity, a library, a large study area and a comfortable bed...With the sliding desk, the problem of space is solved with clever functionality.

SCRITTOIO SCORREVOLE

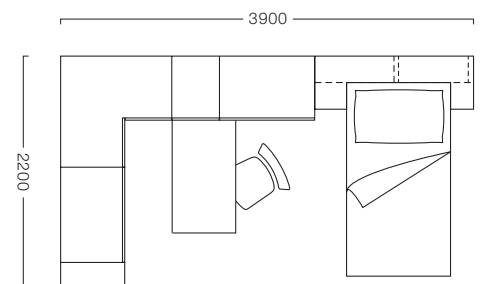





A photograph of a bedroom corner. On the left, a bed is partially visible with a dark headboard and a white pillow. The wall behind the bed is a light-colored brick. The floor is a dark, solid color. In the bottom right corner, a portion of a patterned rug is visible. The word "WALL" is written in white, thin, uppercase letters in the center-right of the image.

WALL





WALL

Un sistema di pannelli modulari a parete, di differenti dimensioni, in melamico, laccato e imbottiti. I pannelli sono affiancabili ed accostabili a piacere all'altezza desiderata in quanto ciascuno è indipendente.

Con Wall è possibile creare pannellature a muro a cui accostare giroletti o divani-letto.

I pannelli wall in melaminico possono essere dotati di luci led che creano un suggestivo effetto luminoso notturno.

A system of modular wall panels, of different sizes, in melamine, lacquered and padded. The panels can be accosted according to your tastes to the desired height, as each one is independent.

With Wall it is possible to create wall panels that can be joined with bed-frame or sofa beds. Melamine wall panels can be equipped with led lights that create a striking night-time effect.



Con il sistema di pannellature Wall, imbottite e in melaminico (o laccate), si creano personali e originali testiere per il letto, con comodino integrato nel pannello a parete. La composizione di queste pagine, realizzata con soli tre pannelli riesce a trasmettere tutta l'originalità ed eleganza del programma, lasciando spazio alla fantasia per creare le più diverse soluzioni personalizzate.

With Wall paneling, upholstered and melamine(or lacquered), you create personal and original hedboard for bed, with bedside table integrated in the wall panel. The composition of these pages, made with only three panels, trasmits all the originality and elegance of the program, leaving space for fantasy to create the most personalized solutions.

S20_T12 :

WALL

Sistema letto pannelli | Wall panels

ARMADIO

Battente con cassetti e libreria | hinged doors with drawers and bookshelf

SCRITTOIO

Sospeso con pensili | Hanging desk with wall units



Platino melaminico

Cemento Bianco melaminico

Avio laccato

Antracite laccato

Tessuto Malvasia TB15





S20_T11

Armadio battente con maniglia Lateral e libreria terminale.
Sistema letto Wall, con giroletto rete 900 e piedino in metallo.
Scrivitoio sospeso, con pensili.

Wardrobe with hinged doors handle lateral and terminal bookcase.
Bed system Wall, ring for base 900 and metal feet.
Hanging desk with boxes.



Spazio alla fantasia e alla personalizzazione: l'innovativo scrittoio sospeso Start.20.20, grazie alla sua modularità, si integra sempre con gli altri elementi del programma quali pensili, casellari e librerie e consente le più varie e funzionali composizioni per la zona studio, davvero originale e pratica.

Originale e polifunzionale anche l'armadio con ante battenti: ante in melaminico Cemento Bianco, cassettiera integrata, terminale a giorno libreria. Difficile chiamarlo semplicemente "armadio".

Space for fantasy and customization: the innovative Start.20.20. Suspended writing desk, thanks to its modularity, is always complemented with other program elements such as wallboxes, hanging boxes, chests and libraries and allows the most varied and functional compositions for the study area original and practical.

Original and multifunctional also the wardrobe with hinged doors: melamine doors Cemento Bianco, integrated chest of drawers, terminal bookcase. Hard to call it simply "closet".

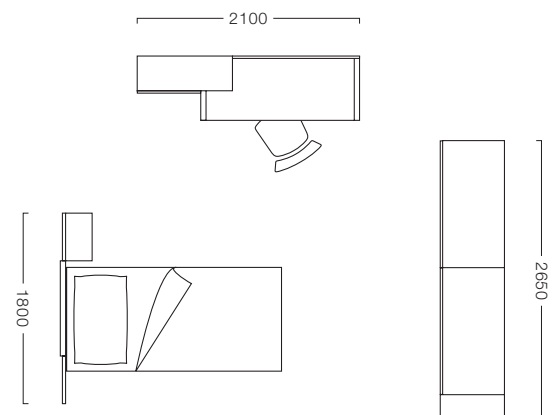





Il sistema letto Wall, formato da pannelli a parete di varie dimensioni, liberamente accostabili a diverse altezze, è ideale per creare soluzioni originali e dal design attualissimo.

Affiancando pannelli in melaminico, laccati e imbottiti si inventano delle composizioni sempre nuove che soddisfano le più diverse esigenze, anche con doppio letto che può successivamente trasformarsi in un grande letto matrimoniale.

I pannelli in melaminico o laccati possono essere dotati a richiesta di luci led notturne a basso consumo per creare suggestivi effetti luminosi o anche per risolvere la paura del buio dei più piccoli.

The Wall bed system, made up of wall panels of various sizes, freely adaptable to different heights, is ideal for creating original solutions as the latest design.

Accosting melamine, lacquered and upholstered panels they invent new and new compositions that meet the most different needs, even with double beds, which can later become a large double bed.

The melamine or lacquered panels can be equipped with low power consumption led lights to create glowing light effects or even to solve the afraid of darkness of the kids.

S20_T13 :

WALL

Sistema letto a pannelli | Wall panels

SNAKE

Mensole modulari | Modular shelves

GHOST

Maniglie a tutta altezza | Full height handles

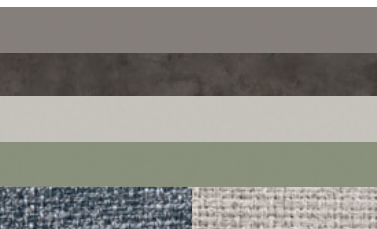

Platino melaminico

Cemento Grigio melaminico

Perla laccato

Laguna laccato

Tessuto Malvasia TB15 - TB11



S20_T13:

Sistema letto Wall, con giroletto rete 900 mm e piedino in metallo Kios.

Tavolino Tripode. Pensile con cassetto.

Mensole Snake. Armadio battente con maniglie Ghost.

Finiture: Platino, Cemento Grigio, Perla, Laguna, Tessuto TB11 e TB15.

Bed system Wall, ring for base 900 and metal feet Kios table Tripode, hanging box with drawer. Shelves Snake wardrobe with handles Ghost.

Finishes: Platino, Cemento Grigio, Perla Laguna, TB11 and TB15 fabric.

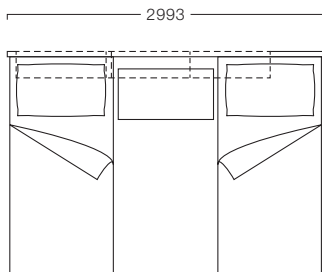



ANTE GHOST INTERNI PRESTIGE

L'armadio di questa composizione è formato da 3 moduli da 900 mm ciascuno con ante battenti da 300 e da 600 mm, una disposizione che crea un design originale grazie anche alla maniglia Ghost nelle ante da 600 mm e nelle cassettiere integrate.

Le cassettiere e gli interni dell'armadio possono essere scelti nella versione "Sport" o "Prestige" come questo armadio: cassetti con fianchi in alluminio verniciato brunito, estrazione totale e rallentatore salvadita in chiusura, fondo da 16 mm.

DOORS GHOST
INTERNALS PRESTIGE

The wardrobe of this composition is made up of 3 modules, 900 mm width each with 300 and 600 mm hinged doors, a layout that creates an original design thanks to the Ghost handle in the 600 mm doors and in the integrated drawers.

The chest of drawers and internals of the closet can be chosen in the "Sport" or "Prestige" version as this wardrobe: drawers completely painted aluminium burnished with 16 mm bottom, total extraction and save-fingers closing.

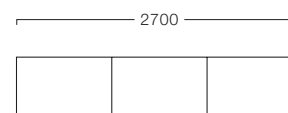



INTERNI "PRESTIGE"

ANTA DA 22 MM CON 6 CERNIERE MOTION
RALLENTATE IN CHIUSURA

*22 MM DOOR WITH 6 MOTION HINGES SOFT
CLOSING SYSTEM*

GUARNIZIONE PARAPOLVERE SU ANTA SX

DUST COVER ON LEFT DOOR

CASSETTO TOTALMENTE IN ALLUMINIO
VERNICIATO BRUNITO CON FONDO DA 16 MM

*DRAWER COMPLETELY PAINTED ALUMINIUM
BURNISHED WITH 16 MM BOTTOM*

CASSETTI AD ESTRAZIONE TOTALE
CON RALLENTATORE IN CHIUSURA
ANTISCHIACCIAMENTO DITA

*TOTAL EXTRACTION DRAWERS WITH
SAVE-FINGERS CLOSING*

TUBO APPENDIABITI LUXURY FINITURA
BRUNITO CON GOMMINI NO-SLIP

*LUXURY CLOTHES HANGER WITH BURNISHED
FINISH AND NO-SLIP RUBBER*





Una composizione ricca di elementi funzionali di grande personalità organizzata intorno al letto Sipario con alette posto in centro stanza.

Sipario è un letto con testiera imbottita, disponibile con una o con doppia aletta laterale oppure lineare.

In queste pagine Sipario dispone di giroletto Tortora con piedini in legno coordinati con lo scrittoio e con i casellari Wood case. Disponibile anche con giroletto imbottito o con box contenitore. Optional la cinghia elastica portaoggetti per le alette del letto.

A rich composition of great personality features arranged around the bed Sipario with wings in the center of the room.

Sipario is a bed with padded headboard, available with one or double side wing or linear version.

In these pages, Sipario has a Tortora bed-frame with wooden feet coordinated with the desk and with the wallboxes Wood Case. Also available with padded bed-frame or storage. Optional elastic belt for the bed wings.

S20_T14:

SIPARIO

Letto imbottito con alette | Upholstered bed with wings

WOOD CASE

Casellari con inserto legno | Boxes with wooden detail

BLOK

Armadio-ponte autoportante | Overhead unit

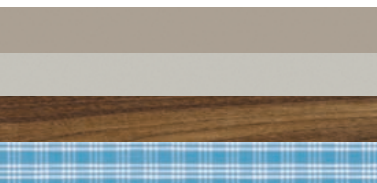

Tortora melaminico

Perla laccato

Noce canaletto essenza

Tessuto Tartan TA27



S20_T14:

Armadio battente con maniglia incasso C17.
Ponte autoportante in appoggio a libreria
spalla a giorno e cassettoni.
Letto Sipario con gambe in legno.
Tavolino Tripode. Basi a terra con cassetti e
maniglia C16. Casellari Wood Case.
Scrivania spess. 30 mm bicolore con gamba
Wood Bridge in legno.

Finiture: Tortora, Perla, Noce canaletto,
Tessuto TA27.

Wardrobe with hinged doors handle C17.
Overhead unit overlapped on a bookcase
and drawers. Bed Sipario with wooden legs.
Table Tripode. Floorstanding boxes with
drawers handle C16. Boxes Wood Case.
Desk th.30 mm bicolored with leg Wood
Bridge.

Finishes: Tortora, Perla, Noce canaletto,
TA27 fabric.

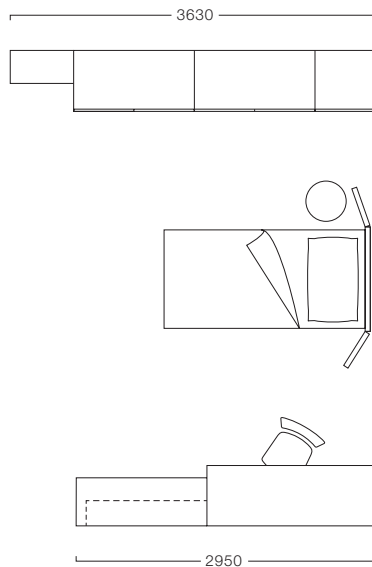



L'armadio con anta battente e il ponte autoportante in appoggio sulla libreria a spalla creano una gradevole area di contenimento a due profondità, con vani a giorno, cassettiere e vani chiusi, ed uno spazio ottimale per l'appoggio della TV. I frontali delle cassettiere sono in essenza legno Noce canaletto, in contrasto con il neutro e caldo colore Perla laccato del resto della composizione.

The wardrobe with hinged door and the overhead unit overlapped on the library create a pleasant enclosed space with open units, drawer and closed units, with double depth and optimum space for TV support. The front of the drawers are Noce Canaletto essence contrasting with the neutral and warm Perla lacquered color of the rest of the composition.





La zona studio - home-office è realizzata con lo scrittoio con piano da 30 mm in Tortora melaminico e gambe Wood Bridge in legno massello tinto Noce canaletto, in appoggio sulle basi a terra con top e frontali cassetti in essenza legno Noce Canaletto e maniglia C17 brunita. Cassetti a estrazione totale, con meccanismo rallentatore in chiusura antirumore e salvadita, con fianchi in alluminio verniciato brunito.

Perfettamente Coordinati con lo stile dello scrittoio i casellari Wood Case a muro, in Tortora melaminico con inserto reggilibri in legno massello tinto noce canaletto. Sedia Zen con gambe legno.

The home-office study area is made up of a desk with a 30 mm top in melamine Tortora and legs Wood Bridge in solid wood painted Noce Canaletto, with base on the ground floor with top and front drawers in wood essence Noce Canaletto and handle C17 burnished. Total extraction drawers, with soft closing and save-fingers system, the guides are in burnished painted aluminium. Perfectly co-ordinated with the style of the writing desk, the Wood Case in melamine Tortora with solid wood-colored Noce Canaletto insert. Zen chair with wood legs.







Sipario con aletta laterale: grazie alla sua eleganza si presta ad essere posto anche come centro stanza, essendo perfettamente rifinito anche sul retro. La composizione continua con il prestigio del vero legno degli inserti delle ante dell'armadio, dei frontali delle basi a terra e dei piedi di letto e dello scrittoio. Raffinato ed elegante il tavolino Tripode, anch'esso con i richiami del legno. La libreria gate in appoggio sulle basi a terra è anche il punto di appoggio dello scrittoio con gambe Wood Bridge.

Sipario with lateral wing: its elegance is also suitable as a center room, being perfectly finished even at the back. The composition continues with the prestige of the real wood of the cabinet door inserts, ground floor fronts and bed feet and desk. Refined and elegant the Tripode table, also with wooden inserts. The Gate bookcase on ground bases is also the point of support of the Wood Bridge legs desk.

S20_T15 :

SIPARIO

Letto imbottito con aletta | Upholstered bed with flap

GATE

Programma casellari modulari | Modular bookshelves

SLIM

Ante armadio con maniglia Lateral | Doors wardrobe with Lateral handle



Tortora melaminico

Miele laccato

Rovere 74 essenza legno

Tessuto Tartan TA26





S20_T15

Armadio battente con anta Slim e maniglia Lateral. Elemento terminale a giorno con appendiabiti. Letto Sipario con gambe in legno. Base a terra con cassetto e libreria Gate in appoggio H. 1104 mm. Scrivitoio spess. 30 mm con gamba Wood Bridge in legno. Tavolino Tripode.

Wardrobe with hinged door Slim and handle Lateral. Open space terminal with clothes hanger. Bed Sipario with wooden legs. Floorstanding box with drawer and overlapped bookcase Gate h. 1104 mm. Desk th 30 mm with Wood Bridge leg. Table Tripode.



ANTE SLIM MANIGLIE LATERAL

Il pregio del vero legno negli inserti delle ante Slim con maniglie a tutta altezza Lateral laccate dello stesso colore dell'armadio come l'ampio terminale a giorno, attrezzato di appendiabiti e ripiani per le cose da avere sempre a portata di mano.

Nella versione "Prestige" di queste foto l'armadio è attrezzato con appenderia interna brunita, ante con 6 cerniere e rallentatore in chiusura, guarnizione parapolvere.

SLIM DOOR - LATERAL HANDLE

The value of real wood in the Slim door inserts with all-height Lateral lacquered handles of the same color of the closet as the large open terminal, equipped with hangers and shelves for things to keep handy.

In the "Prestige" version of these pictures the wardrobe is equipped with burnished internal hangers, 6 hinged doors with soft closing, saving dust rubber.

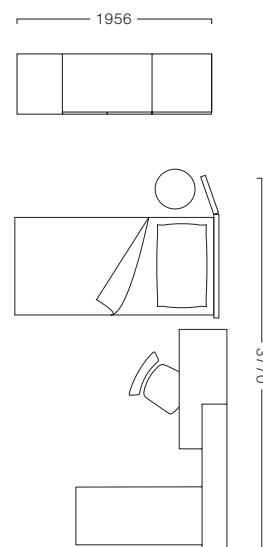







GATE

Programma librerie modulari
Modular bookshelves

Dettaglio libreria sospesa Gate
con scrittoio inserito

*Detail of suspended bookcase Gate with
inserted desk*



START.20.20

COMPOSIZIONI A PONTE
OVERHEAD COMPOSITION



Una composizione eclettica e dinamica, dominata dalla scansione dei moduli delle librerie Gate in contrappunto con la solida geometria del ponte autoportante Blok.

Il letto con testiera curva Tonga è un esempio di virtuosismo costruttivo e di eleganza, sottolineato dalle gambe trasparenti in materiale plastico.

Completa la composizione lo scrittoio con gambe Slim laccate e piano da 30 mm in melaminico Olmo Cenere con bordo in tinta con le gambe Slim.

An eclectic and dynamic composition, dominated by the Gate modular libraries being scanned in counterpoint with the solid geometry of the self-supporting Blok bridge.

The Tonga curved headboard is an example of constructive and elegant virtuosity, underlined by the transparent plastic legs.

The composition is completed by the writing desk with Slim lacquered legs and 30 mm top in melamine Olmo Cenere with edge same color of the Slim legs.

S20_P16 :

TONGA

Letto con testiera curva | Bed with curved headboard

GATE

Programma librerie modulari | Modular bookshelves

SLIM

Gambe scrittoio | Desk side legs



Olmo Cenere melaminico

Tortora melaminico

Laguna laccato

Muschio laccato





S20_P16

Armadio battente con maniglia C07. Ponte autoportante Blok.
Libreria Gate H.368-1104. Letto Tonga rete da 900. Base con cassettoni.
Scrivania spess. 30 mm bicolore con gamba Slim.

Wardrobe with handle C07. Overhead unit Blok.
Library Gate H.368-1104. Bed Tonga for base 900. Box base with drawer.
Desk th. 30 mm. Bicolored with leg Slim.



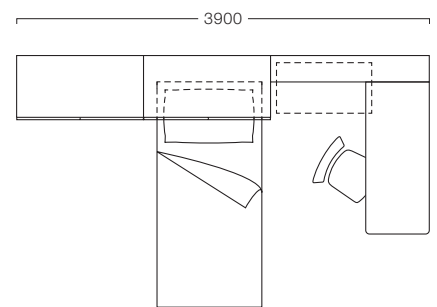

Dettaglio maniglia C07 laccata Muschio.
Dettaglio libreria Gate H.368-1104.

*Detail of handle C07 lacquered Muschio.
Detail of Gate modular bookshelves H.368-1104.*





La modularità degli elementi, l'armadio, il laterale a giorno con specchio e il ponte Blok autoportante creano una composizione organica e suggestiva nella quale trova spazio in modo perfetto il sommier Turca con rete da 900 e i pannelli imbottiti Cloud fissati alla schiena sottoponte per creare una soffice testiera.

L'eleganza continua con la libreria Gate da cui nasce lo scrittoio spessore 50 mm in melaminico Cemento Bianco sostenuto dalla gamba Charme in metallo brunito.

The modularity of the elements, the side wardrobe with mirror and the self-supporting bridge Blok create an organic and evocative composition in which perfect space is located the Turca bed 900 mm width and the padded panels Cloud fixed to the bridge backs, to create a soft headboard.

The elegance continues with the Gate library from which borns the desk 50 mm thick in melamine Cemento Bianco supported by the leg Charme in burnished metal.

S20_P17:

BLOK

Ponte autoportante | Overhead unit

CLOUD

Pannelli imbottiti multiuso | Upholstered panels

GATE

Programma librerie modulari | Modular bookshelves



Lavanda melaminico

Cielo melaminico

Cemento Bianco melaminico

Tortora melaminico

Tessuto Alice TA36-TA37



La composizione S20_P17 in dettaglio:
armadio laterale con specchio e attrezzato
di ripiani e tubo appendiabiti, armadio
battente con maniglia C05 brunita, ponte
autoportante Blok.

Giroletto Turca rete 900, pannellatura Cloud
in Tessuto TA36-TA37, cassetiera con
maniglia C04 brunita.

Libreria Gate H 1104 con scrittoio
spessore 50 mm e gamba Charme.

Finiture: Lavanda, Cielo, Cemento Bianco,
Tortora, Tessuto TA36-TA37

Composition S20_P17: Lateral wardrobe
with mirror and equipped with shelves and
hanging rods. Wardrobe with handle C05
burnished. Self supporting bridge Blok.
Bed ring for base 900. Panelling Cloud
TA36-TA37 fabric. Chest of drawers with
handle C04 burnished. Library Gate H. 1104
with desk th. 50 mm. Leg Charme.

Finishes: Lavanda, Cielo, Cemento Bianco,
Tortora, TA36-TA37 fabric.

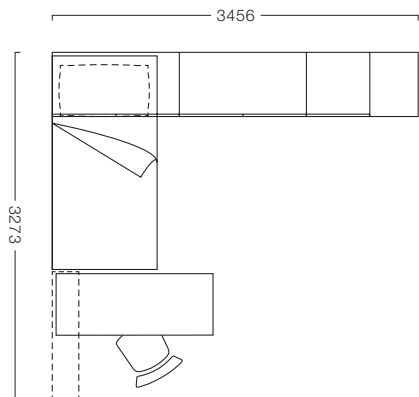



Dettagli preziosi e coordinati nel design: le maniglie in metallo brunito C05 richiamano i tondini metallici della gamba Charme. Il melaminico Dekor Cemento Bianco delle ante da 22 mm dell'armadio e del ponte Blok è disponibile anche con spessore 50 mm per lo scrittoio. I colori dei tessuti sono armoniosamente coordinati con gli azzurri Lavanda e Cielo di cassetiera e libreria Gate.

Precious and coordinated details in design: the C05 brown metal handles call the Charme leg metallic rods. The melamine Dekor Cemento Bianco of the 22 mm door of the closet and the Blok bridge is also available with 50 mm thick for the desk. The colors of the fabrics are harmoniously coordinated with lavender blue and Cielo of the drawers and Gate bookshelf.









KOLLEKTOR SCHÖNEN BELEBEN
THE SWEDISH INTERIOR DESIGN GADGETS FROM EVERMOTION



In un piccolo spazio tante soluzioni, molta funzionalità e un grande design.

Nell'area libera sotto il ponte Blok trova posto lo scrittoio spessore 50 mm con fianco libreria e la cassetiera sospesa che diventa anche il comodino per il letto creato dai pannelli imbottiti Cloud e dal sommier turca con box contenitore.

In a small space many solutions, many features and great design.

In the free area under the Blok bridge, there is a 50 mm thick desk with bookcase side and the suspended chest of drawers, which also becomes the bedside table created by the padded Cloud panels and the sommier with a storage box.

S20_P18 :

BLOK

Ponte autoportante | Overhead unit

STRIPE

Maniglie a tutta altezza | Full height handles

CLOUD

Pannelli imbottiti multiuso | Upholstered panels



Neve melaminico

Beige melaminico

Verde melaminico

Marina laccato

Tessuto TA26-TA46





S20_P18

Armadio laterale attrezzato di ripiani e tubo appendiabiti. Armadio battente con maniglia Stripe. Ponte autoportante Blok con maniglie Stripe. Scrivitoio spess. 30 mm con fianco libreria. Pensile con cassetto uso comodo. Giroletto turca rete 900. Pannellatura Cloud in Tessuto TA26-TA46. Mensole con schiena.



Lateral wardrobe equipped with shelves and hanging rods. Wardrobe with handle Stripe. Self supporting bridge Blok with handles Stripe. Desk th. 50 mm with side bookcase. Hanging box with drawer for nightstand use. Bed ring for base 900. Panelling Cloud TA26-TA46 fabric. Shelves with back.

Neve, Verde e Beige sono i tre colori melaminici di questa composizione, con i tocchi laccati Marina delle maniglie, della cassetteria e altri dettagli, creando un insieme fresco e delicato.

Neve, Verde and Beige are the three melamine colors of this composition, with the lacquered Marina handles, chest of drawers and other details, creating a fresh and delicate set.

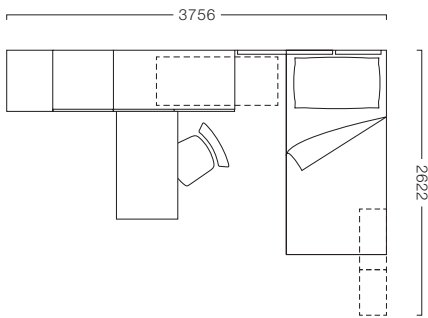



L'armadio laterale con ripiani e appendiabiti è una grande opportunità per rifinire in modo elegante e pratico la parte terminale dell'armadio che di solito rimane inusato.

Il design dell'armadio laterale è richiamato anche dal fianco libreria dello scrittoio, che offre la possibilità di essere realizzato anche bicolore, come in questo caso con l'accostamento dei colori Marina e Verde.

The side closet with shelves and the coat rack is a great opportunity to finish elegantly and practically the closet that usually remains unused.

The side cabinet design is also recalled from the side of the desk bookcase, which offers the possibility of being made even bicolor, as in this case with the approach of the colors Marina and Verde.

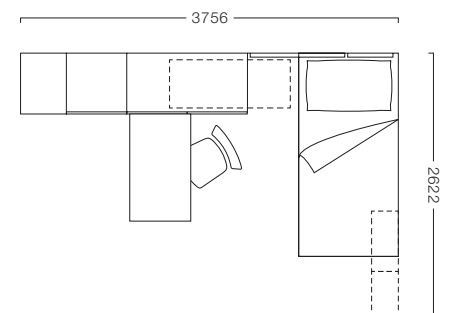



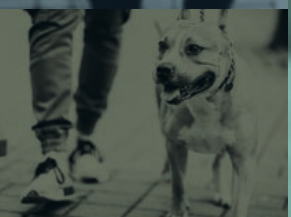





Tra le molte configurazioni del sistema letti XL anche questa funzionale possibilità di integrarsi con il ponte autoportante Blok grazie alla libreria di raccordo sottoponte.

XL con la sua profondità di 100 cm offre in questo caso tre capienti cassettoni su ruote totalmente estraibili.

Perfettamente in linea con lo spirito geometrico e minimale di XL lo scrittoio spessore 50 mm con gambe quadro, anch'esse da 50 mm.

Among the many configurations of the XL beds system is also to integrate with the self-supporting Blok bridge thanks to the underbridge fitting library.

XL with its depth of 1000 mm offers in this case three generous drawers on totally removable wheels.

Perfectly on line with the geometric and minimalistic spirit of XL, the 50mm thick desk with legs.

S20_P19 :

XL SYSTEM

Programma letti con cassettoni | Bed with pullout drawers

QUADRO

Gambe per scrittoi e letti | Legs for desks and beds

GHOST

Ante con maniglia a gola | Doors with Gola Handles

Platino melaminico

Cemento Grigio melaminico

Marina laccato

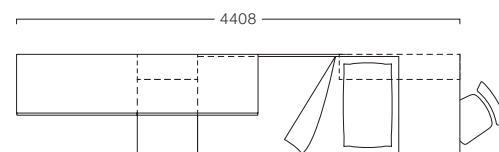





S20_P19

Armadio battente con maniglia Ghost. Ponte autoportante con maniglia Ghost. Letto XL con libreria di raccordo sotto ponte. Scrittoio spess. 50 mm con gamba Quadro laccata. Libreria Gate H. 368 mm.

Wardrobe with handle Ghost. Self-supporting bridge with handle Ghost. Bed XL with bookcase under the bridge. Desk th.50 mm with lacquered leg Quadro. Bookcase Gate h.368 mm.



Forme minimali e geometriche con XL System, definite con cura in ogni dettaglio: ad esempio i cassettoni estraibili sono privi di maniglioni per non interferire con la linearità del design, per estrarli basta tirare l'apposita sporgenza dei frontali oltre il piano del letto.

Il piano su cui poggia il materasso ha la profondità di 100 cm e dispone di 8 fori di aerazione da 50 mm rifiniti con bordo in materiale plastico.

Minimal and geometric shapes with XL System, carefully defined in every detail: for example, pull-out drawers are free of handles so as not to interfere with the linearity of the design, to open them just pull the special projection of the fronts over the bed plane.

The platform on which the mattress rests has a depth of 1000 mm and has 8 ventilation holes of 70 mm finished with plastic edge.



Dettaglio letto XL con cassettone chiuso con sporgenza per apertura.
Pagina a fianco: zona studio con scrittoio spess. 50 e gamba quadro laccata. A parete libreria Gate H 368 mm.

*Detail of bed XL with open drawer on wheels.
Next page: detail of study area with desk th. 50 and lacquered leg Quadro. Bookcase Gate h. 368 mm.*





Lo spazio per due non è mai abbastanza, ma la soluzione con i letti XL offre la più grande possibilità di contenimento, funzionale ed elegante allo stesso tempo.

Il design raffinato è sottolineato dagli accostamenti di colore: Olmo Scuro e Tortora esaltati dai tocchi dell'attualissimo colore Miele laccato.

The space for two is never enough, but the solution with the XL beds offers the greatest possibility of containment, functional and elegant at the same time.

The refined design is highlighted by the color combinations: Olmo Scuro and Tortora exalted by the touches of the latest Miele lacquered color.

S20_P20 :

XL SYSTEM

Programma letti con cassettoni | Bed with pullout drawers

BLOK

Ponte autoportante | Overhead unit

SLIM

Gambe per scrittoi | Legs for desks



Tortora melaminico
 Olmo Scuro melaminico
 Miele laccato

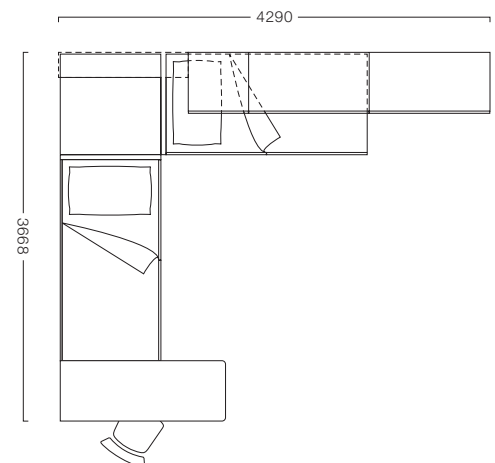







S20_P20

Ponte autoportante Blok con maniglie Lateral.
Armadio battente con maniglia Lateral. Letti XL ad angolo.
Scrivitoio spess. 50 mm con gambe Slim.

Wardrobe with handle Lateral. Self supporting bridge Blok
with handle Lateral.
Corner beds XL. Desk th. 50 mm with legs Slim.





XL

Sistema letti con cassettoni estraibili
Bed with pullout drawers





I grandi cassettoni sono indipendenti su ruote, possono essere estratti totalmente e spostati a piacere

The large chest of drawers are independent on wheels and can be extracted and completely moved to taste



Quando lo spazio diventa ristretto entra in scena Lobby: un programma vasto e versatile di letti sovrapposti, estraibili, con cassettoni ed altri accessori.

In questa composizione nello spazio sottoponte trovano posto i due letti Lobby e lo scrittoio con ruote. Il letto Lobby basso su ruote dispone di due cassettoni.

When the space becomes restricted, Lobby takes part: a vast and versatile program of overlapping, extractable beds, with drawers and other accessories.

In this composition the two Lobby beds and the desk with wheels find their space under the bridge. The lower Lobby bed on wheels has two drawers.

S20_P21:

LOBBY

Programma letti estraibili | Pullout beds

PONTE

Ponte a terra | Overhead units

STRIPE

Maniglie decorative laccate | Laquered decorative handles

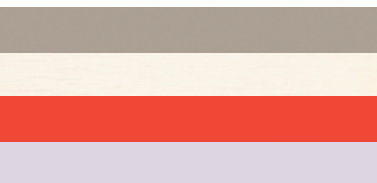

Tortora melaminico

Neve melaminico

Papavero melaminico

Ciclamino laccato

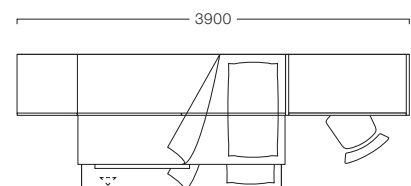



Composizione S20_P21 composta da:
armadio battente con maniglia Stripe,
ponte a terra con maniglie Stripe e
fianchi a "c".

Letti Lobby basso ed estraibile con
cassettoni.

Scrivania spess. 30 mm scorrevole.

Finiture: Neve, Tortora, Papavero,
Ciclamino.

Composition S20_P21: wardrobe with
handle Stripe, floorstanding bridge with
handle Stripe and "C".

Sides lower beds Lobby and pull out
drawers; sliding desk th. 30 mm.

Finishes: Neve, Tortora, Papavero,
Ciclamino.

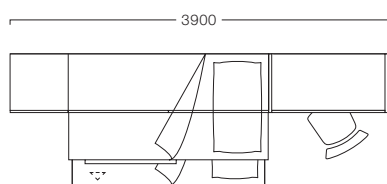





Armadio "Corner", armadio battente e Ponte "a terra" formano la grande zona di contenimento che lascia spazio anche per il letto Puzzle con pianale e gamba Slitta laccata. L'armadio "Corner" consente di proseguire la composizione ad angolo con le basi a terra e i casellari Cross in appoggio sul fianco dell'armadio, senza sprecare spazio prezioso.

La zona studio è realizzata con lo scrittoio da 50 mm con gambe slitta e da una composizione di casellari Cross bicolore, originali e innovativi.

Corner wardrobe, hinged door wardrobe and floorstanding bridge form the large containment area that leaves space for the Puzzle bed with platform and with lacquered Slitta leg. The wardrobe Corner allows you to continue the corner composition with the bases on the ground and Cross wallboxes on the side of the closet without wasting valuable space.

The study area is made with a 50mm desk with Slitta legs and bicolour Cross wallboxes, original and innovative.

S20_P22 :

PUZZLE

Letto con gambe Slitta | Bed with Slitta legs

CROSS

Casellari modulari | Modular wallboxes

SLITTA

Gambe per letti e scrittoi | Legs for beds and desks



Olmo Chiaro melaminico

Neve melaminico

Perla laccato

Miele laccato



Composizione S20_P22: armadio Corner battente con maniglia C03. Armadio battente con maniglia C03.

Ponte a terra con fianco a "C".

Letto Puzzle con pianale e gamba Slitta.

Casellari Cross. Scrivitoio spess. 50 mm con gamba Slitta in appoggio a base a terra con cassetti.

Finiture: Olmo Chiaro, Neve, Perla, Miele.

Composition S20_P22: Corner wardrobe with handle C03; wardrobe with hinged door handle C03; floorstanding bridge with side "C".

Bed Puzzle with wooden platform and leg Slitta. Boxes Cross. Desk th. 50 mm. with leg Slitta overlapped on a box base with drawers.

Finishes: Olmo Chiaro, Neve, Perla, Miele.

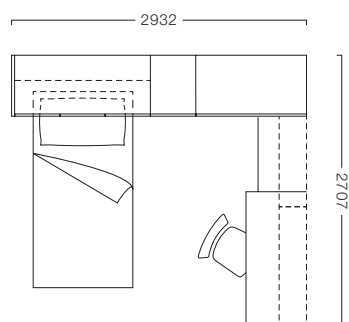



L'armadio Corner è la soluzione per ottenere la massima capienza anche nelle composizioni ad angolo, come in questo caso. È attrezzato internamente di ripiani e tubi appendiabiti nelle versioni "Prestige" in metallo brunito o "Sport" in metallo cromato. Optional luci interne a led.

Nella pagina a fianco: zona studio realizzata con coppia di casellari Cross laccati bicolore a parete e scrittoio spess. 50 mm con gamba Slitta laccata.

The Corner wardrobe is the solution for maximum capacity even in corner compositions, as in this case. It is equipped internally with shelves and hanger tubes in "Prestige" versions in burnished metal or "Sport" in chromed metal. Optional internal LED lights.

On next page: studio area made with two Cross lacquered modular wallboxes, chest of drawers and desk with Slitta lacquered leg.







La particolare attenzione costruttiva dei "ponti a terra" rende le composizioni lineari e raffinate, come in questo caso di ponte ad angolo dove le ampie superfici in Olmo Sbiancato esprimono tutta la loro eleganza.

Non vi è necessità di avere maniglie nelle ante del "ponte": l'impugnatura si ottiene dalla sporgenza delle stesse rispetto alla struttura. Con l'aggiunta del terminale libreria si completa sia l'aspetto visivo che quello funzionale.

La raffinatezza continua con la scelta del letto Botton, dalla morbida testiera imbottita, e con le sinuosità del piano scrittoio e il suo cassetto nascosto.

The special construction of the "bridges on the floor" makes the compositions linear and refined, as in this case an corner bridge where the large surfaces in Olmo sbiancato express all their elegance.

There is no need to have handles in the "bridge" doors: the handle is obtained from the projection of the same with respect to the structure. Adding the library terminal completes both visual and functional aspects.

The sophistication continues with the choice of the Botton bed, the soft padded headboard and the sinuousness of the writing desk and its hidden chest.

S20_P23 :

BOTTON

Letto con testiera imbottita | Bed with upholstered headboard

PONTE

A terra, ad angolo | Bridge floorstanding, corner

LIBRERIA

Fianco ponte | Bridge side library

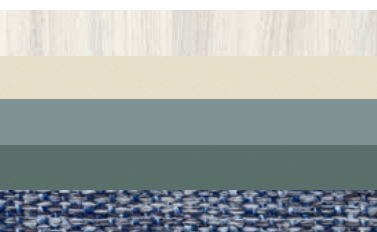

Olmo Sbiancato melaminico

Beige melaminico

Avio laccato

Muschio laccato

Tessuto Baloo TA46





S20_P23

Armadio battente con maniglia C11. Ponte a terra ad angolo con fianco libreria. Letto imbottito Botton rete 900. Scrivitoio spess. 30 mm con elemento retro letto estraibile.



Wardrobe with handle C11. Floorstanding corner bridge with library side. Upholstered bed Botton for base 900. Desk th. 30 mm with pull out bed back item.



MASSIMA FUNZIONALITÀ



Ogni centimetro è prezioso e merita di essere sfruttato al meglio: ecco quindi l'intelligente soluzione che riesce a sfruttare lo spazio dietro al letto e sotto lo scrittoio con un praticissimo cassettone estraibile su ruote, un contenitore dove riporre anche oggetti ingombranti di uso stagionale.

Per l'utilizzo quotidiano la soluzione della cassetiera integrata nell'armadio formata da due cassetti di differente capienza. In questa composizione i cassetti e gli interni sono nella versione "Prestige": cassetti ad estrazione totale con fianchi in alluminio verniciato brunito e rallentatore in chiusura anti schiacciamento dita, le ante sono dotate di parapolvere e cerniere con rallentatore; l'appenderia interna in metallo brunito.

Every inch is precious and deserves to be exploited at its best. This is the clever solution that manages to take advantage of the space behind the bed and underneath the desk with a handy movable chest of drawers, a container that also houses bulky seasonal goods.

For everyday use, the chest of drawers is integrated into the cabinet made up of two drawers of different capacity. In this composition the drawers and the interiors are in the "Prestige" version: full extraction drawers with aluminum painted sides and soft closing save-fingers, the doors are equipped with saving dust rubber and soft closing hinges; the internal hangers in burnished metal.

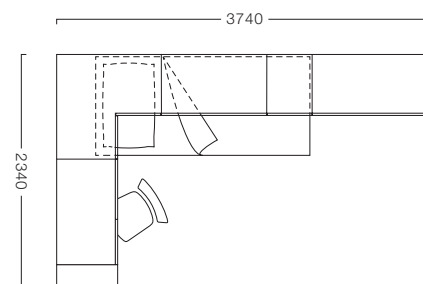





A close-up photograph of a textured grey fabric headboard and a white pillow on a bed. The headboard has a tufted design. The pillow is white and appears to be made of a soft, possibly cotton, material. The word "BOTTON" is overlaid in white, uppercase, sans-serif font on the right side of the pillow. The overall lighting is soft and even, highlighting the textures of the fabrics.

BOTTON



Un'altra composizione lineare per risolvere gli spazi ristretti ma anche per le zone della casa dove sia necessario un grande armadio contenitore con la possibilità di avere un letto in più per gli ospiti.

Il letto Lobby con cassettoni si inserisce nel vano del ponte a terra Store, e può anche essere allestito come divanetto con cuscini in appoggio. All'occorrenza si estrae facilmente grazie alle ruote di cui è dotato ed è già pronto per la notte.

Another linear composition for solving the restricted spaces but also for the areas of the house where a large storage cupboard is needed, with the possibility of having an extra bed for the guests.

The Lobby bed with drawers is inserted into the bridge Store, and can also be set up as a sofa with pillows in support. When needed it is easily removed thanks to the wheels it is equipped with and is ready for the night.

S20_P24 :

MAXI

Armadio con ante battenti | Wardrobe with hinged doors

STORE

Ponte a terra | Floorstanding bridge

LOBBY

Programma letti estraibili | Pull out bed system

Neve melaminico

Platino melaminico

Cemento Grigio melaminico

Avio laccato



L'armadio Maxi con la sua profondità di 1050 mm è una soluzione efficace per ampliare la capacità di contenimento nello stesso spazio di un armadio normale.

La composizione S20_P24 è così formata: armadio Maxi con maniglia C17 cromo, ponte a terra Store, armadio battente con cassetti e maniglie C17-C16 cromo; letto Lobby estraibile con cassettoni.

Finiture: Neve melaminico, Platino melaminico, Cemento Grigio melaminico, Avio laccato.

The Maxi wardrobe with its depth of 1050 mm is an effective solution to widen the containment capacity in the same space as a normal wardrobe.

Composition S20_P24 is formed as: Maxi wardrobe with C17 chrome handle, Store bridge, wardrobe with drawers and handles C17-C16 chrome; Pull-out Lobby bed with drawers.

Finishes: Melamine Neve, Melamine Platino, Melamine Cemento Grigio, Avio lacquered.

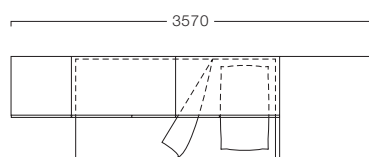



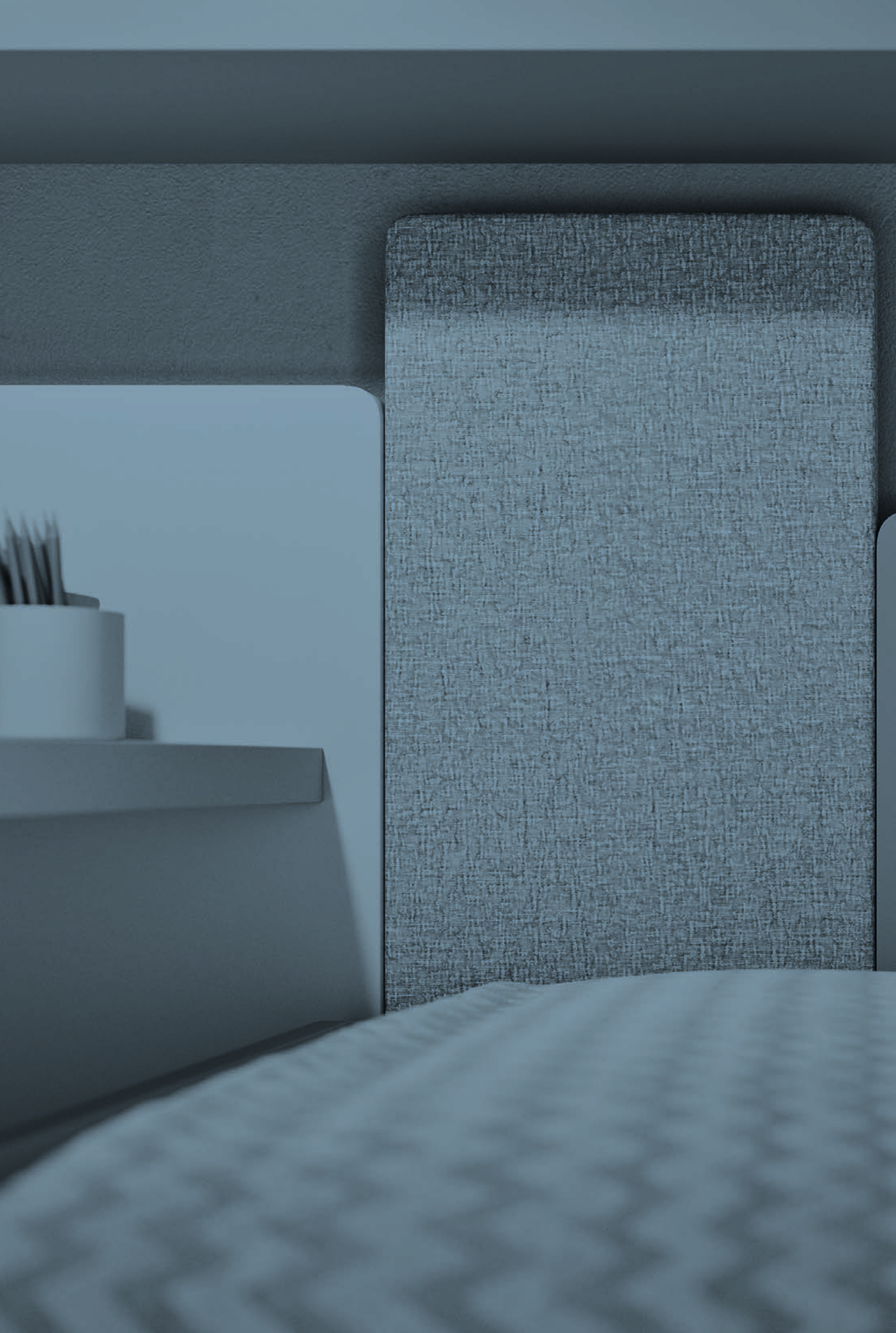

A dark, textured wall with a white rectangular panel and a dark fabric panel. The word "WALL" is written in white capital letters on the dark fabric panel.

WALL



Ancora una volta Start.20.20 riesce a mettere insieme design e funzionalità interpretando con originalità ogni tipo di spazio.

L'affascinante sequenza dei pannelli imbottiti e laccati Cloud, disposti come schienale per il letto Lobby, cattura subito l'attenzione. Ma le soluzioni innovative sono molte: dalla grande cabina Lite con terminale libreria e il ponte Blok affiancato ad angolo. La zona scrittoio è posta perpendicolarmente alla parete abbellita dalla mensola Snake.

Once again, Start.20.20 manages to combine design and functionality by interpreting every kind of space with originality.

The fascinating sequence of Cloud padded and lacquered panels, arranged as a backrest for the Lobby bed, immediately captures the attention. But the innovative solutions are many: from the large Lite cabinet with bookcase terminal and the corner Blok bridge. The desk area is placed perpendicularly to the wall embellished by the Snake Shelf.

S20_P25 :

LITE

Cabina armadio | Corner Cabinet

WALL

Sistema pannelli letto | Paneling system

LOBBY

Programma letti estraibili | Pull out bed system

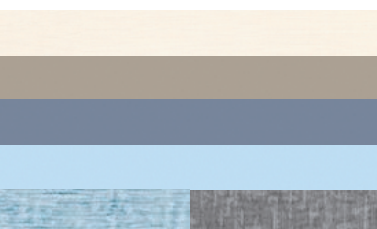

Neve melaminico

Tortora melaminico

Oceano laccato

Lavanda melaminico

Tessuto Alice TA36-TA39





S20_P25

Cabina angolo Lite con maniglia C22. Libreria terminale. Ponte autoportante Blok. Sistema letto Wall, letto Lobby estraibile con cassettoni. Mensola Snake. Scrivitoio spess. 50 mm con fianco spess. 50 mm.

Corner cabinet Lite with handle C22. Terminal library self supporting bridge Blok. Bed system Wall, pull-out bed Lobby with drawers. Shelf Snake desk th. 50 mm. With side th. 50 mm.



LITE CABINA ANGOLO

La cabina Angolo Lite è la soluzione ideale per avere uno spazio ordinato e lineare esternamente e una grande capacità interna di contenere anche oggetti ingombranti.

Può essere attrezzata con ripiani, appendiabiti e cassettiere a seconda delle necessità, ed è possibile, come in questo esempio, rifinire il fianco a vista con la grande libreria, utile e di grande impatto estetico.

CORNER CABIN LITE

The Corner Cabin Lite is the ideal solution for having an ordered and linear space externally and a large internal capacity to contain bulky objects as well.

It can be equipped with shelves, coat racks and drawers as needed, and it is possible, as in this example, to trim the side view with the large bookcase, useful and of great aesthetic impact.

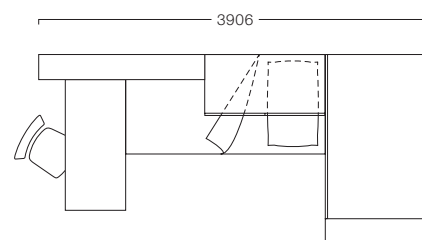







LOBBY

Programma letti multifunzione

Sistema pannelli letto

Dettaglio dei 2 cassettoni estraibili su guida del letto multifunzione Lobby.

Detail of the 2 pull-out drawers on the Lobby's multifunction bed.

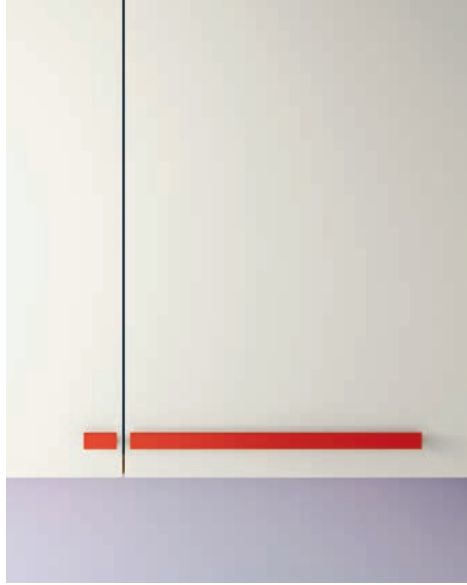

Un esempio delle grandi possibilità compositive del programma Lobby di letti estraibili. La collezione Lobby è composta da oltre 10 diversi modelli polifunzionali salvaspazio di varie dimensioni e molte soluzioni con cassettoni, cassettiere integrate, letti estraibili e anche una versione con letti e scrittoio estraibile.

Una composizione "salvaspazio" ma anche un esempio di eleganza e raffinatezza, grazie alla cura dei dettagli e l'accostamento dei colori laccati Ciclamino e Papavero con i melaminici Olmo Chiaro e Beige.

An example of the great compositional possibilities of the Lobby program of pull beds. The Lobby collection is made up of over 10 different multifunctional space saving solutions of various sizes and many solutions with chest of drawers, integrated drawers, removable beds and also a removable bed version and desk.

A "space-saving" composition, but also an example of elegance and sophistication, thanks to the attention to detail and the combination of lacquered colors Ciclamino and Papavero with Olmo Chiaro and Beige melamine.

S20_P26 :

LOBBY

Programma letti salvaspazio | Space-saving bed system

BLOK

Ponte autoportante | Self supporting bridge

GATE

Librerie modulari | Modular bookshelves

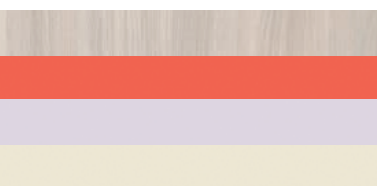

Olmo Chiaro melaminico

Papavero melaminico

Ciclamino laccato

Beige melaminico

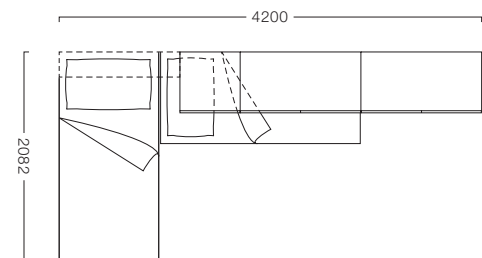





S20_P26

Armadio battente con maniglia Stripe. Ponte autoportante Blok con maniglie Stripe. Letto Lobby Corner, con letto Lobby estraibile. Libreria Gate H. 368.

Wardrobe with handle Stripe. Self supporting bridge Blok with handles Stripe. Corner bed Lobby, with pull-out bed Lobby. Library Gate h. 368.



Gli interni degli armadi possono essere scelti in una delle 6 finiture melaminiche "di struttura": Bianco, Neve, Olmo Sbiancato, Olmo Chiaro, Olmo Cenere, Olmo Scuro. Optional i ripiani e le cassettiere interne possono essere nel colore laccato preferito.

INTERNALS: FREEDOM TO PERSONALIZE

The interiors of the cabinets can be chosen in one of the 6 "structure" melamine finishes: Bianco, Neve, Olmo sbiancato, Olmo chiaro, Ash Olmo cenere, Olmo scuro. Optional shelves and internal drawer units can be in the preferred lacquer color.

GLI INTERNI: LIBERTÀ DI PERSONALIZZARE



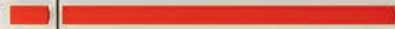

Lobby Corner è un letto di grande capacità contenitiva, con due o tre cassetti e un grande vano accessibile da una comoda rete rialzabile servoassistita.

Con il programma Lobby si ottengono tutte le soluzioni d'arredo anche dove lo spazio sembra impossibile.

LOBBY CORNER: SOLUTIONS FOR ALL SPACE

Lobby Corner is a bed of large capacity, with two or three drawers and a large compartment accessed by a convenient servo assisted bed base.

With the Lobby program you get all the furniture solutions where space seems impossible.

LOBBY CORNER: SOLUZIONI PER OGNI SPAZIO









APOLLO

Divano letto

Sofa-bed



In uno spazio ristretto una grande soluzione d'arredo, funzionale e intelligente con vani a giorno, vani chiusi e anche con le nuove ante in vetro fumé e profilo in alluminio brunito.

Una stanza polivalente da vivere sia di giorno che di notte, con tutto il necessario per il massimo comfort abitativo e un look di grande attualità.

In a small space, a large, functional and smart furnishing solution with vanity compartments, closed compartments and even with new smoked glass doors and burnished aluminum frame.

A multifunctional living room both day and night, with everything you need for maximum comfort and a great look.

S20_P27 :

APOLLO

Divano letto | Sofa bed

DUPLO

Armadio ad angolo | Corner wardrobe

LIBRERIA

Libreria sottoponte | Under-bridge library



Olmo Scuro melaminico

Tortora melaminico

Avio laccato

Vetro fumé

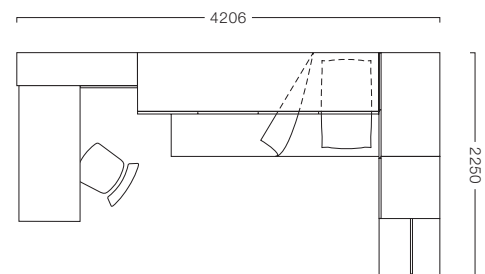





S20_P27

Appendiabiti esterno su panca Ambrogio. Armadio battente e cassetti con maniglie C16-C17 brunate. Armadio Duplo. Divano-letto Apollo. Ponte autoportante Blok con ante vetro telaio brunito, vetro fumé. Libreria a spalla sottoponte con scrittoio spess. 30 mm e gamba Kios metallo brunito.

External hanging clothes on bench Ambrogio with handle C16-C17 and drawers with handles C16-C17. Armario Duplo. Sofa bed Apollo. Self supporting bridge Blok with glass doors, burnishe frame, fumé glass. Shelf under the bridge with desk th.30 mm and leg Kios metal burnishe.



Sono i dettagli che fanno la differenza, e Start.20.20 offre sempre la massima qualità e attenzione anche nelle piccole cose, come le finiture in metallo brunito coordinato nelle maniglie e nei profili delle ante, così come negli interni o nelle gambe dello scrittoio.

Details make the difference, and Start.20.20 always offers the highest quality and attention even in small things, such as burnished finishes in the handles and door frames, as well as in the interior or the legs of the desk.







START.20.20

COMPOSIZIONI SALVASPAZIO
SPACE-SAVING COMPOSITIONS



Un gioiello da esporre a centro stanza: il suo nome è Slide ed è un castello scorrevole con soppalco. Nel mondo dei salvaspazio Slide è uno dei protagonisti grazie alla semplicità di utilizzo e l'estrema compattezza.

Il letto inferiore su ruote è uno tra i molti modelli della serie Lobby che in caso di necessità può essere scelto nella versione con cassettoni o con terzo letto estraibile.

A jewel to be displayed in the center of the room: its name is Slide and it is a sliding bunkbed with loft. In the world of space-saving solutions, Slide is one of the protagonists thanks to its simplicity of use and its extreme compactness.

The lower bed on wheels is one of the many models of the Lobby series which, if necessary, can be chosen in the version with drawers or with a third pull-out bed.

S20_S28:

SLIDE

Letto a soppalco scorrevole | Sliding Loft bed

LOBBY

Programma letti salvaspazio | Space-saving bed system

PUZZLE

Armadio con ante scorrevoli | Wardrobe with sliding doors

Tortora melaminico

Cemento Bianco melaminico

Malva laccato

Cedro laccato





S20_P28

Letto Soppalco Slide con letto inferiore Lobby estraibile.
Armadio scorrevole Puzzle.
Scrivania spess. 50 mm con gambe Slitta.

Loft bed Slide with pull out lower bed Lobby.
Wardrobe with sliding doors Puzzle.
Desk 50 mm thick with Slitta legs.



120 centimetri le dimensioni delle ante Puzzle e quindi anche l'ampio spazio dei due vani interni dell'armadio. L'anta scorrevole è una delle soluzioni più pratiche per avere tutto sott'occhio e a portata di mano in quanto libera completamente il vano senza alcun intralcio. Le ante Puzzle possono essere personalizzate differenziando i quattro moduli esterni rispetto all'insero centrale.

PUZZLE: SLIDING DOORS

120 cm the size of the Puzzle Slides and therefore also the large space of the two inner compartment spaces. The sliding door is one of the most practical solutions to have everything under your eye and at your fingertips as it completely frees the compartment without any hassle. Puzzle doors can be customized by differentiating the four outer modules from the central insert.

PUZZLE: ANTE SCORREVOLI

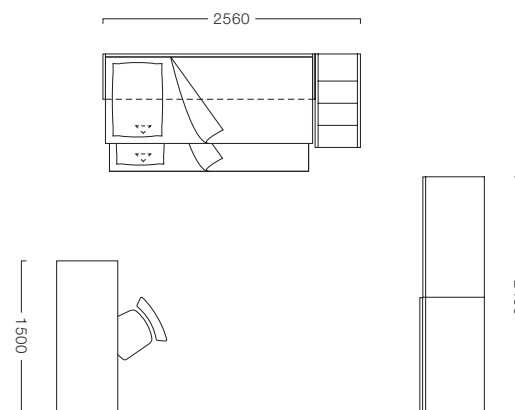



Come il design di Slide, lo scrittoio con gamba slitta offre le geometrie squadrate e le morbidezze degli angoli arrotondati, in perfetta armonia. Un oggetto di pregio e originale con il piano e i raccordi con spessore 50 mm che si allineano con il cassetto e alle speciali slitte in metallo che lo sostengono. Piano, cassetto e gambe Slitta possono essere scelti nel colore preferito.

DESK 50 MM THICK + SLITTA

Like the Slide design, the desk with slitta leg offers square geometries and smoothness of rounded corners in perfect harmony.

A precious and original object with the top and joints with a thickness of 50 mm aligning with the drawer and special metal slitte supporting it. Top, drawer and Slitta legs can be chosen in the preferred color.

SCRITTOIO SP. 50 + SLITTA











Il vero castello "delle avventure" che sogna ogni ragazzo: la grande e spaziosa pedana con scalini posta sul retro, la libreria, gli spazi nascosti per riporre gli oggetti personali (pedana e scaletta sono dotati di vani nascosti con apertura a botola).

L'armadio Maxi completa la composizione salvaspazio grazie alla sua grande capienza e la sua profondità maggiorata.

Il letto inferiore Lobby offre ulteriori funzioni di contenimento con i due grandi cassettoni estraibili su guide.

The true "adventures" castle that every boy dreams : the large, spacious platform with stairs on the back, the bookcase, the hidden spaces to store the personal belongings (platform and staircase are equipped with hidden spaces with trapdoor).

The Maxi closet completes the space saving composition thanks to its large capacity and its increased depth.

The Lower Lobby bed offers additional containment functions with the two large extractable drawers.

S20_S29 :

SOPPALCO

Lineare con pedana | Loft bed Linear with platform

DAMA

Protezioni imbottite removibili | Removable upholstered protections

LOBBY

Programma letti salvaspazio | Space-saving bed system



Olmo Chiaro melaminico

Beige melaminico

Lavanda melaminico

Oceano laccato

Tessuto Alice TA33



BOOKS

Composizione salvaspazio composta da Armadio Maxi con maniglia C11, letto Soppalco-ponte lineare con pedana e libreria a giorno con schiena.

Letto superiore con protezione Dama imbottita in tessuto TA33.

Il letto inferiore Lobby estraibile è dotato di cassettoni.

Finiture: Olmo Chiaro melaminico, Beige melaminico, Lavanda melaminico, Oceano laccato, Tessuto TA33.

Space-saving composition with wardrobe Maxi with handle C11, bed linear Loft-bridge with platform and bookcase with back. Upper bed with protection Dama upholstered Fabric TA 33. The pull out lower bed has drawers included.

Finishes : Olmo Chiaro melamine, Beige melamine, Lavanda melamine, Oceano lacquered, Fabric TA33.

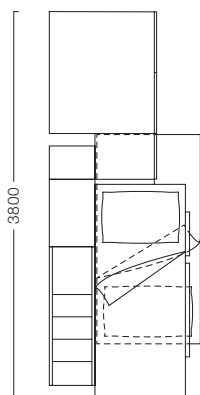



Divertente per i ragazzi, ma soprattutto pratico e funzionale, il soppalco con gradini offre una piattaforma usabile anche per rifare il letto con facilità, i vani a giorno ricavati al termine della pedana sono utili e belli.

LOFT BED WITH LIBRARY

Fun for the kids, but above all practical and functional, the loft with steps offers a platform that can also be used to remake the bed easily, the open spaces at the end of the platform are useful and beautiful.

SOPPALCO CON LIBRERIA





L'armadio Maxi, con la sua profondità di 1050 millimetri offre un doppio spazio per tubi appendiabiti, ripiani e cassettiere.

Può essere personalizzato internamente a seconda delle proprie esigenze con cassettiere di varie dimensioni o con ripiani.

DOUBLE DEPTH

The Maxi wardrobe, with its depth of 1050 millimeters, offers a double space for coat hangers, shelves and drawers.

It can be customized internally depending on your needs with drawers of various sizes or with shelves.

DOPPIA PROFONDITÀ





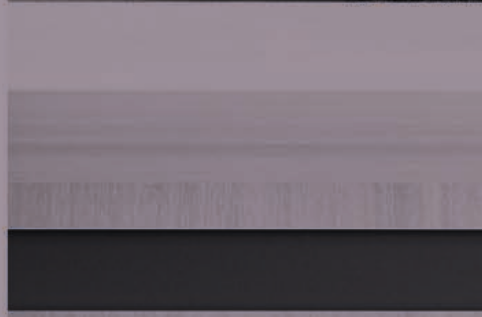





Una composizione ricca di spunti e suggerimenti per arredare con creatività la stanza da letto e guadagnare spazio per studiare, giocare, ricevere amici.

Il letto a soppalco 90° con salita posteriore è integrato con l'armadio ponte che ospita nella parte inferiore il letto a scomparsa polifunzionale Nikai.

Quando il letto Nikai è chiuso la zona inferiore diventa uno salottino da usare per i giochi o per ricevere gli amici. Poi basta reclinare l'anta ed ecco che magicamente appare il letto già pronto per l'ospite.

A rich composition of ideas and suggestions to creatively furnish the bedroom and gain space for studying, playing, and receiving friends.

The 90 ° loft bed with rear climb is integrated with the bridge closet that houses the Nikai multifunctional bed at the bottom.

When the Nikai bed is closed the bottom area becomes a sitting room to use for games or to receive friends. Then just close the door and here is that magically appears the bed ready for the guest.

S20_S30 :

SOPPALCO

Con salita posteriore | Loft bed with rear climb

NIKAI

Letto polivalente a vagone | Multifunctional wagon bed

DAMA

Protezioni sagomate rimovibili | Removable shaped protections

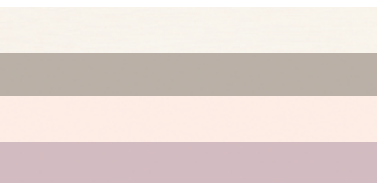

Neve melaminico

Tortora melaminico

Confetto melaminico

Antico laccato



In queste pagine: il letto a vagone Nikai in posizione chiusa e aperta. È disponibile anche nella versione con scrittoio esterno che "scivola" sotto il letto senza ribaltarsi durante l'apertura dell'anta, letto Yori collezione InMotion di Start.

In these pages: the wagon bed Nikai in closed and open position. It is also available in the exterior desk version that "slides" under the bed without tilting during the opening of the door, Yori bed Start InMotion collection.

LETTO NIKAI

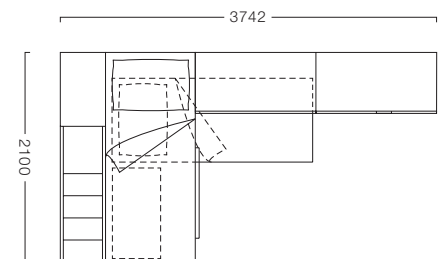



ARMADIO

L'armadio, con la sua profondità offre un grande spazio per riporre tutto in perfetto ordine. Può essere personalizzato internamente a seconda delle proprie esigenze con doppio appendiabiti, cassettiere di varie dimensioni o con ripiani.

Il grande maniglione C22 laccato diventa un piacevole elemento decorativo riproposto nella cassettiera e nell'anta a ribalta del letto Nikai. La sua forma arrotondata richiama il design delle protezioni Dama laccate.

WARDROBE MAXI

The wardrobe, with its depth, offers a great space to store everything in perfect order. It can be customized internally depending on your needs with double hangers, drawers of various sizes or shelves.

The large lacquered C22 handle becomes a delightful decorative element in the chest of drawers and in the folded door of the Nikai bed. Its rounded shape recalls the design of lacquered Dama protections.







S20_S30

Armadio battente con ante Slim e maniglia C22.
Letto Soppalco 90° ponte, con protezione Dama e salita posteriore.
Letto polifunzionale Nikai inferiore. Base a terra con cassettoni.

Hinged wardrobe with doors Slim and handle C22.
Loft bed 90° bridge, with protection Dama and rear climb.
Lower multifunctional bed Nikai. Base box with drawer.





Scorrevole per il divertimento dei ragazzi e pratico per risolvere i problemi di spazio che non mancano mai.

Il soppalco scorrevole con salita posteriore mantiene le stesse dimensioni di un soppalco fisso una volta aperto, ma quando è chiuso libera lo spazio sottostante per le attività diurne dei ragazzi.

Un sofisticato gioco di incastri trasforma le librerie a giorno e cassettiere visibili frontalmente nella "scaletta" e pedana del letto superiore.

Sliding for kids fun and practical to solve the space problems that never miss.

The sliding loft bed with rear climb keeps the same size as a fixed loft bed when opened, but when it is closed it frees the space below for the daytime activities of the boys.

A sophisticated gaming transforms the bookcases and drawer units, which are visible in front of the "ladder" as platform of the upper bed.

S20_S31:

SOPPALCO

Sorrevole con salita posteriore | Loft bed sliding with rear climb

TRIGO

Collezione casellari | Wallboxes collection

CASE

Collezione casellari | Wallboxes collection

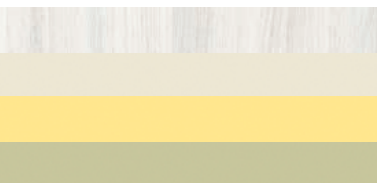

Olmo Sbiancato melaminico

Beige melaminico

Mimosa melaminico

Malva laccato

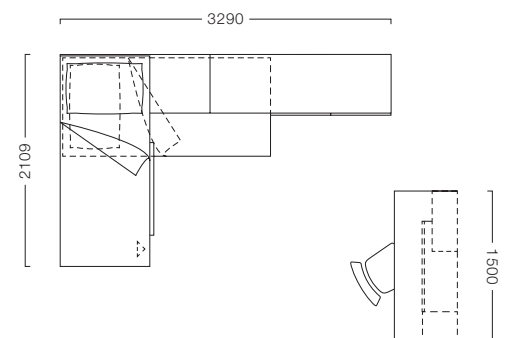



HAPPY

?

THINK OUTSIDE THE BOX





S20_S31

Armadio battente con anta Stripe bicolore. Letto Soppalco scorrevole.
Giroletto turca inferiore. Scrivitoio sospeso spess. 50 mm.
Casellario Trigo, pensile a ribalta, casellari Case.

Hinged wardrobe with door Stripe bicolored.
Sliding loft bed. Lower bed frame. Suspended desk 50 mm thick.
Wallbox Trigo, box with flap door, wallboxes Case.



Il letto superiore del soppalco scorrevole è agganciato a parete con il binario sul quale scorre, mentre la parte terminale dispone di ruote. Quindi farlo scivolare è un'operazione da ragazzi, facile e sicura.

MOVE IT AND CLIMB

The upper bed of the sliding loft is hooked to the wall with the track on which it runs, the terminal part having wheels. So making it slide is a fun task, easy and safe.

LO SPOSTI E SALI





SCRITTOIO
SOSPESO,
PENSILE
A RIBALTA
PUSH-PULL,
CASELLARI
CASE E TRIGO;
SEDIA CORAL.

Scrittoio sospeso spess. 50 mm. Casellario Trigo,
pensile a ribalta, casellari Case. Sedia Coral.

*Desk Suspended, flap hanging box with push pull
opening, wallboxes Case and Trigo; chair Coral.*

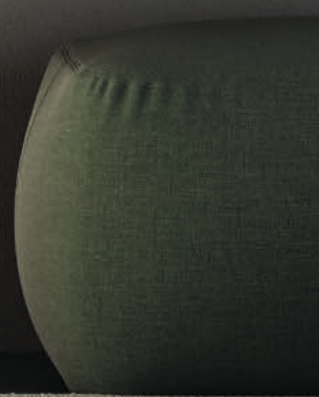

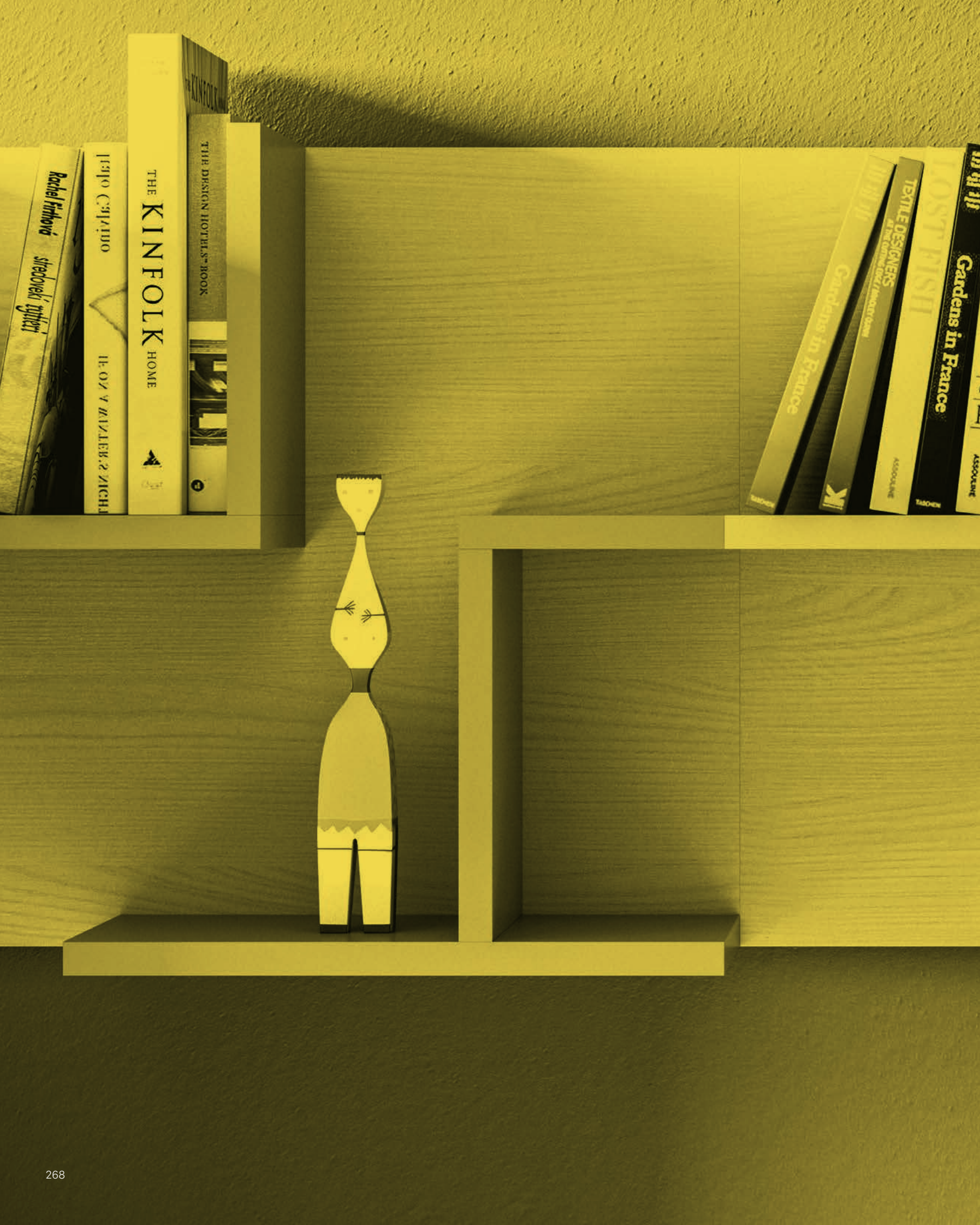

Rachel Firthová
středověké typy

1190 Caprino

THE KINFOLK HOME

THE DESIGN HOTEL'S BOOK

HE OZ V KINZLER'S NICH

Gardens in France

TEXTILE DESIGNERS
AT THE CUTTING EDGE / PRODUCT DESIGN

POSTPISH
Gardens in France

Over the Top
LOST FISH
EERO SAARINEN
FRANK LLOYD WRIGHT
ASSOCIATE

2002
2002
2014
2014
Lebanon
2002
COSMOPOLITAN
2002

CROSS

2004
2008

Rachel Firthová středověcí rytíři



Con il Castello Sky si apre finalmente una nuova era per quanto riguarda il look dei letti a castello, portando il design più attuale anche in questa tipologia di arredo per la zona notte.

Linee rette, geometrie definite e campi di colore per creare l'atmosfera personalizzata.

Con Sky il letto a castello con scaletta non è più un ripiego salvaspazio ma l'oggetto dei desideri di ogni ragazzo.

With Sky bunk bed finally opens up a new era with regard to the look of the bunk beds, bringing the most contemporary design to this type of furniture for the sleeping area.

Straight lines, defined geometries and color fields to create a personalized atmosphere.

With Sky, the bunk bed with ladder is no longer a space saving item but the object of every boy's wishes.

S20_S32 :

SKY

Castello con scaletta | Bunk bed with ladder

TEX

Letto a terra | Floorstanding bed

CROSS

Casellario modulare | Modular wallbox



Olmo Sbiancato melaminico

Tortora melaminico

Avio laccato

Marina laccato





S20_S32

Armadio battente con maniglia Ghost. Cabina Naked brunita con ripiani e tubi appendiabiti. Letto castello Sky con scaletta in metallo frontale. Letto inferiore Tex con piedini Kios in metallo. Scrittoio spess. 50 mm con fianco spess. 50 mm. Casellari Cross.

Hinged wardrobe with doors Olmo sbiancato and drawers lacquered Avio and Marina; handles Ghost lacquered Avio and Marina. Burnished cabin Naked with shelves Olmo sbiancato and burnished coat hangers with antislip rubber.



Armadio battente con ante in Olmo Sbiancato e cassetti laccati Avio e Marina; maniglie Ghost laccate Avio e Marina.

Cabina Naked brunita con ripiani in Olmo sbiancato e tubi appendiabiti in metallo brunito con gommino antiscivolo.

Hinged wardrobe with doors Olmo Sbiancato and drawers lacquered Avio and Marina; handles Ghost lacquered Avio and Marina.

Burnished cabin Naked with shelves Olmo Sbiancato and burnished coat hangers with antislip rubber.

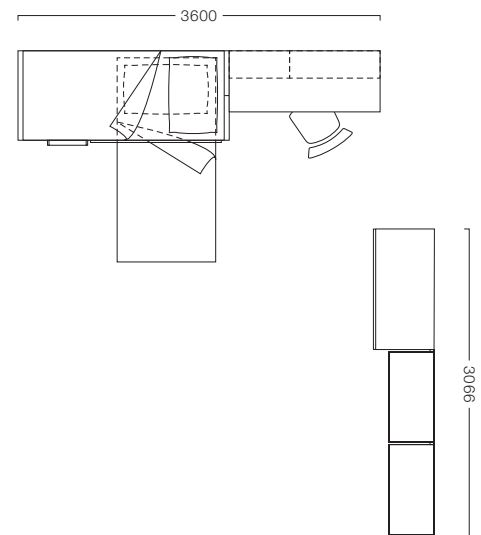



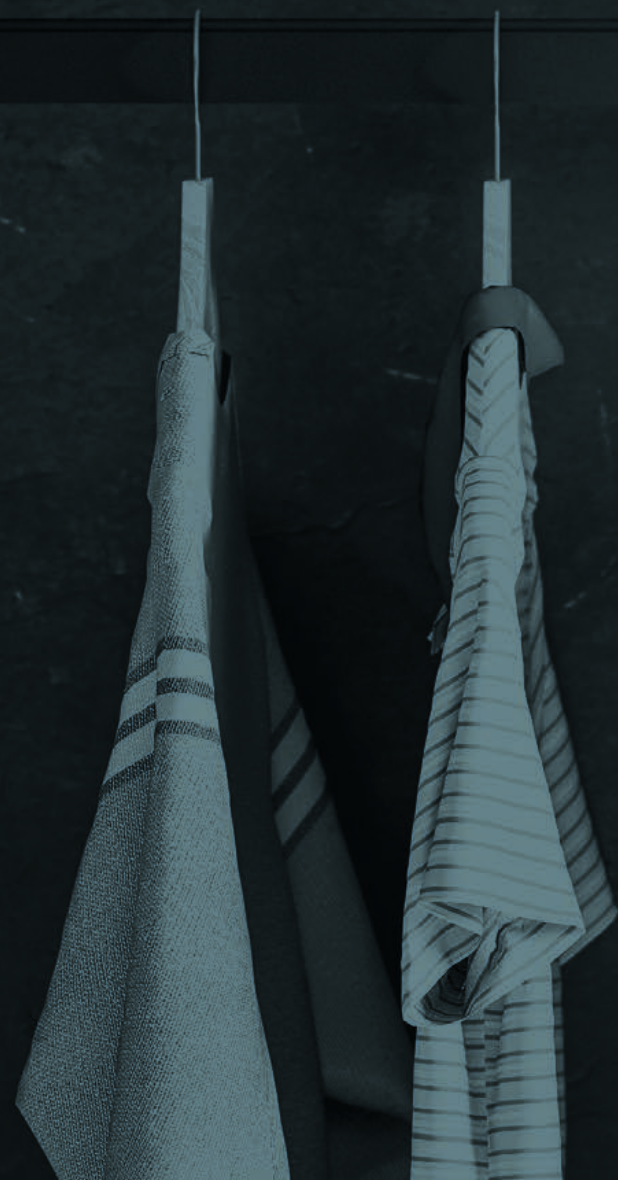





Sky, il castello con scaletta incorporata, doppio letto e scrittoio con gamba Charme: design e funzionalità in pochissimo spazio.

Lo spazio guadagnato con il castello Sky diventa una grande opportunità di contenimento con la cabina armadio angolare attrezzabile internamente con ripiani, appendiabiti ed anche cassettiere.

Sky, bunk bed with ladder, double bed and desk with leg Charme. Design and functionality in very little space.

The space gained with the Sky Castle becomes a great opportunity to contain the corner cabin that can be fitted internally with shelves, hangers and drawer units.

S20_S33 :

SKY

Castello con scaletta | Bunk bed with ladder

CHARME

Gambone per scrittoi | Leg for desks

CABINA

Cabina-armadio angolare | Corner cabin-wardrobe

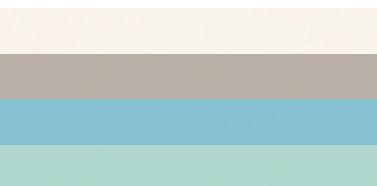

Neve melaminico

Tortora melaminico

Cielo melaminico

Marina laccato

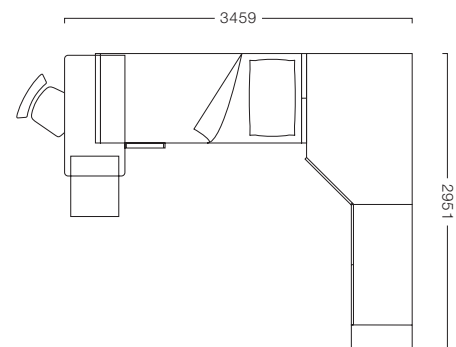





S20_S33

Libreria terminale. Armadio battenti con maniglia C03.
Cabina armadio con maniglia C03. Letto castello Sky con scaletta
in metallo frontale e scrittoio con gamba Charme.

Terminal bookcase. Hinged wardrobe with handle C03.
Cabin with handle C03. Bunk bed Sky with ladder with metal front
and desk with leg Charme.



Il letto inferiore del castello Sky è dotato di un grande cassettone per contenere giochi, o biancheria o gli oggetti ingombranti che non si vuole avere in giro.

La cabina armadio angolare è un formidabile aiuto per riporre in ordine abbigliamento, biancheria e oggetti di grandi dimensioni.

SPACE FOR EVERYTHING

The lower bed of the bunk bed Sky can be equipped with a large dresser to hold games, lingerie or bulky items that you do not want to have around.

The corner cabinet is a formidable aid for storing clothing, lingerie and large items.

SPAZIO PER TUTTO











La più classica delle disposizioni lineari reinterpretata con la nuova filosofia Start.20.20.

I letti sovrapposti a sbalzo in linea formano ora una composizione organica e coordinata, con lo spazio per lo studio, le librerie e il contenimento.

Con il letto inferiore della collezione XL System lo spazio sotto il letto diventa totalmente utilizzabile grazie ai grandi cassettoni su ruote estraibili; gli spessori di 50 mm creano un forte impatto estetico e sono richiamati anche nel mensolone a parete e nello scrittoio perpendicolare con gambe Quadro.

The most classic of the linear arrangements reinterpreted with the new philosophy Start.20.20.

Overlapping beds on the line now form an organic and coordinated composition, with study space, libraries and containment.

With the lower bed of the XL System collection space under the bed becomes fully usable thanks to the large drawers on extractable wheels; the 50 mm thickness creates a strong aesthetic impact and are also recalled in the wall shelves and in the perpendicular desk with Quadro legs.

S20_S34 :

CASTELLO

A sbalzo con scaletta | Bunk bed with ladder

XL SYSTEM

Letto inferiore con libreria | Lower bed with bookcase

LATERAL

Maniglia armadio | Handle for wardrobe

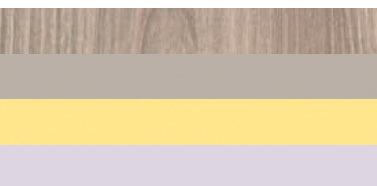

Olmo Cenere melaminico

Tortora melaminico

Mimosa melaminico

Ciclamino laccato

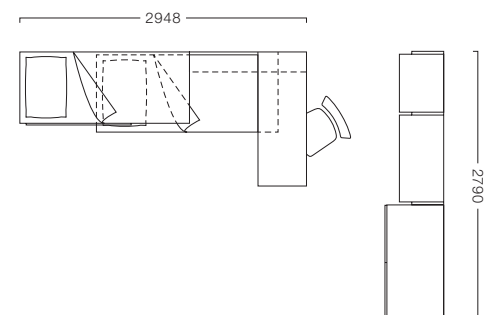





S20_S34

Letto castello a sbalzo con scaletta in metallo. Letto inferiore XL con fianco libreria. Scrigno spess. 50 mm con gambe Quadro. Armadio battente e cassetti con maniglie Lateral. Cabina Flexy con ripiani e tubi appendiabiti.

Bunk bed with metallic ladder. Lower bed XL with bookcase side. Desk 50 mm thick with Quadro legs. Hinged wardrobe and drawers with handles Lateral. Cabin Flexy with shelves and coat hangers.



Grandi possibilità di contenimento grazie all'armadiatura sottostante il letto superiore con profondità di 90 cm e i cassettoni estraibili del letto XL. Il letto XL è formato da un piano forato sul quale poggia direttamente il materasso.

Great possibilities of containment thanks to the cabinet underneath the upper bed with depth of 90 cm and removable drawers of the XL bed. The XL bed is made of a perforated platform on which the mattress is located directly.







THE 7TH SENSE
PATH TO PARADISE
Chris Leland

BECAUSE of YOU
Sara M. Middle
Benjamin O'Neil / John Gray / Tony Jones / Steven Weber

The 7th SENSE
PATH TO PARADISE
Chris Leland

MAKING IT
HOW TO GET THERE
AND STAY THERE
Chris Leland

LOST FISH
NEW URBAN HOUSING
HEAVY FRESH
Chris Leland

Gardens in France
ALEXEY BRODOVITCHI!
HEAVY FRESH
Chris Leland





Ancora una nuova versione del Castello Sky: con "camminata" ad accesso posteriore e con le protezioni Dama imbottite.

Le protezioni Dama sono disponibili in tutti i colori melaminici, in tutti i colori laccati e tutti i tessuti ed ecopelle.

La struttura metallica di sostegno del letto dispone di un appendiabiti e di mensola bassa per appoggiare indumenti e oggetti.

Il letto turca inferiore è dotato di box contenitore. I "mensoloni" della scaletta posteriore diventano un appoggio-testiera portaoggetti per il letto inferiore.

Another new version of the Bunk bed Sky: with "walking" rear access and upholstered protections Dama. Dama protections are available in all melamine colors, in all lacquered colors and all fabrics and eco-leather. The metal support frame of the bed has a coat rack and a low shelf to support garments and objects.

The lower bedframe has a storage box. The "shelves" of the rear ladder becomes a back-resting headboard for the lower bed.

S20_S35 :

SKY

Castello con camminata | Bunk bed with walking

DAMA

Protezioni imbottite | Upholstered protections

SMART

Sommier-turca con box | Bedframe with box



Olmo Sbiancato melaminico

Tortora melaminico

Cielo melaminico

Tessuto Rally TA16 - TA17

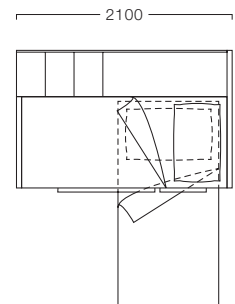





S20_S35

Armadio battente con maniglie Stripe. Letto a castello Sky con camminata e protezioni Dama imbottite in Tessuto TA16 e TA17. Giroletto turca Smart imbottita in Tessuto TA17.

Hinged wardrobe with handle Stripe. Bed Sky with rear walking and protections Dama upholstered with Fabric TA16 and TA17. Bedframe Smart upholstered with Fabric TA17.



Armadio battente struttura in Olmo Sbiancato melaminico e ante in Tortora melaminico, con maniglie stripe in laccato Sky. Gli interni sono nella versione "Sport" con appendiabiti in metallo cromato.

Hinged wardrobe in melamine structure Olmo Sbiancato and doors in melamine Tortora, with Sky lacquered Stripe handles. The internals are in the "Sport" version with chromed metal hanger.

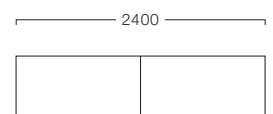



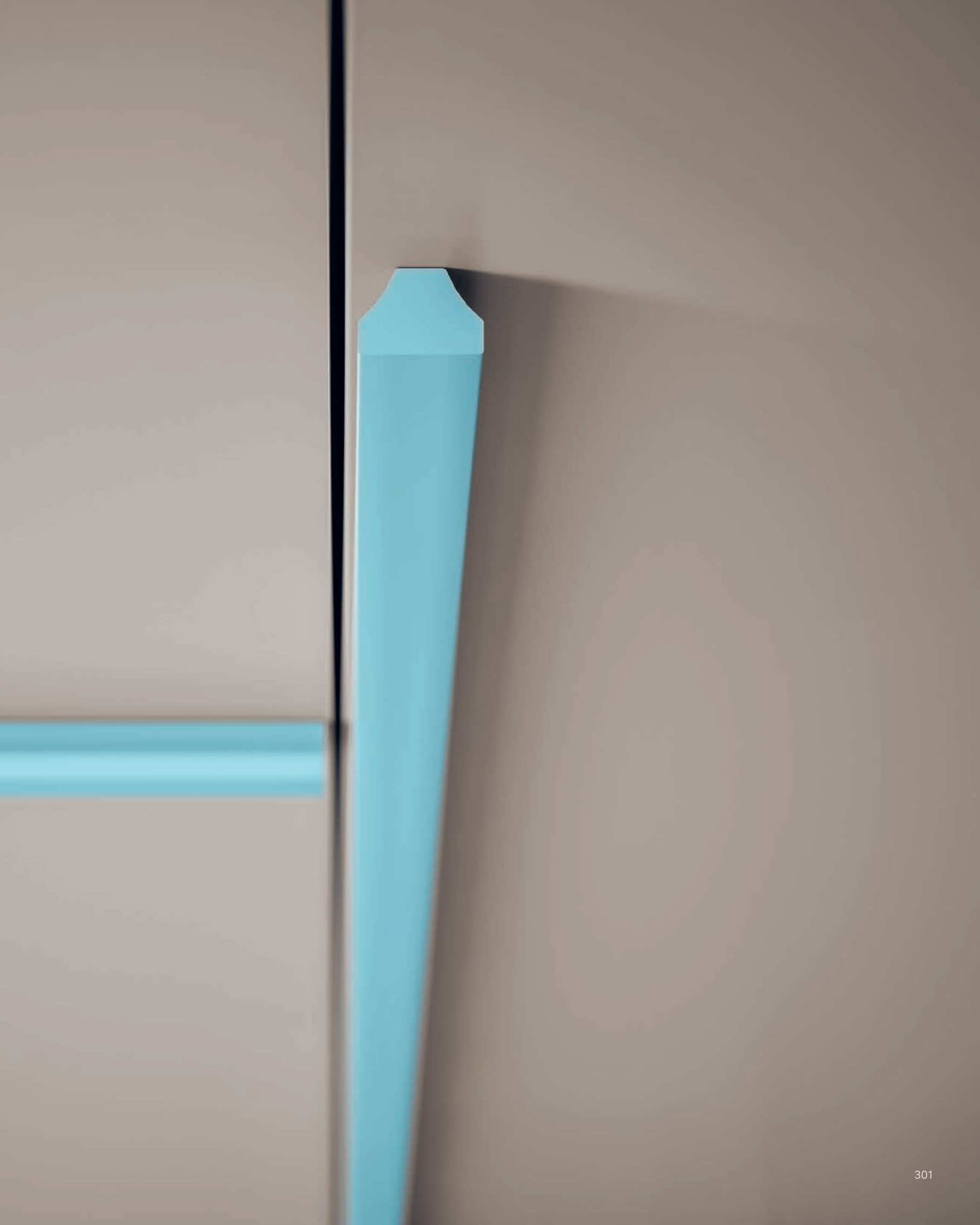



START.20.20

ABACO PRODOTTI
LIST OF PRODUCTS

START.20.20

ABACO PRODOTTI
LIST OF PRODUCTS

Una vasta gamma di letti con infinite possibilità di personalizzazione: letti in melaminico, laccati e imbottiti, con accessori e possibilità di scegliere tra diversi giroletti e piedini. Gran parte dei letti Start.20.20 sono disponibili anche in versione da una piazza e mezza o matrimoniale e con lunghezza maggiorata per materasso da 2100 mm.

FLOORSTANDING BEDS

A wide range of beds with endless possibilities of customization: melamine beds, lacquered and padded beds, with accessories and a choice of different bedframes and legs. Most of the Start.20.20 beds are also available in a one and a half size or double bed version and have a longer length for a 2100 mm mattress.

LETTI A TERRA



LETTI A TERRA

LETTO **BASE**



MISURE DISPONIBILI (mm)

L. 890 P. 1990 H. 910 RETE 800 X 1900
 L. 990 P. 2040 H. 910 RETE 900 X 1950
 L. 1290 P. 2040 H. 910 RETE 1200 X 1950
 L. 1690 P. 2040 H. 910 RETE 1600 X 1950

L. 990 P. 2190 H. 910 RETE 900 X 2100
 L. 1290 P. 2190 H. 910 RETE 1200 X 2100
 L. 1690 P. 2190 H. 910 RETE 1600 X 2100

VARIANTI GIROLETTO OPTIONAL

A B C D E F G H I L

LETTO **BASE IMBOTTITO**



MISURE DISPONIBILI (mm)

L. 890 P. 1990 H. 910 RETE 800 X 1900
 L. 990 P. 2040 H. 910 RETE 900 X 1950
 L. 1290 P. 2040 H. 910 RETE 1200 X 1950
 L. 1690 P. 2040 H. 910 RETE 1600 X 1950

L. 990 P. 2190 H. 910 RETE 900 X 2100
 L. 1290 P. 2190 H. 910 RETE 1200 X 2100
 L. 1690 P. 2190 H. 910 RETE 1600 X 2100

VARIANTI GIROLETTO OPTIONAL

A B C D E F G H I L

LETTO **TEX**



MISURE DISPONIBILI (mm)

L. 890 P. 1990 H. 910 RETE 800 X 1900
 L. 990 P. 2040 H. 910 RETE 900 X 1950
 L. 1290 P. 2040 H. 910 RETE 1200 X 1950

L. 990 P. 2190 H. 910 RETE 900 X 2100
 L. 1290 P. 2190 H. 910 RETE 1200 X 2100

VARIANTI GIROLETTO OPTIONAL

A B C D E F G H I L

VARIANTI GIROLETTO OPTIONAL



A

Pediera a terra con angoli 90°

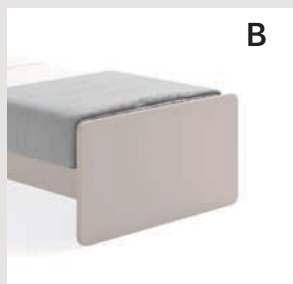

B

Pediera a terra con angoli arrotondati



C

Giroletto con piedini legno 50x50 mm



D

Giroletto con piedini Kios 20x20 mm



E

Giroletto con piedini Lateral

LETTO NADIR



MISURE DISPONIBILI (mm)

L. 890 P. 1990 H. 910 RETE 800 X 1900
 L. 990 P. 2040 H. 910 RETE 900 X 1950
 L. 1290 P. 2040 H. 910 RETE 1200 X 1950
 L. 1690 P. 2040 H. 910 RETE 1600 X 1950

L. 990 P. 2190 H. 910 RETE 900 X 2100
 L. 1290 P. 2190 H. 910 RETE 1200 X 2100
 L. 1690 P. 2190 H. 910 RETE 1600 X 2100

VARIANTI GIROLETTO OPTIONAL

B C D E F G H I L

LETTO NADIR IMBOTTITO



MISURE DISPONIBILI (mm)

L. 890 P. 1990 H. 910 RETE 800 X 1900
 L. 990 P. 2040 H. 910 RETE 900 X 1950
 L. 1290 P. 2040 H. 910 RETE 1200 X 1950
 L. 1690 P. 2040 H. 910 RETE 1600 X 1950

L. 990 P. 2190 H. 910 RETE 900 X 2100
 L. 1290 P. 2190 H. 910 RETE 1200 X 2100
 L. 1690 P. 2190 H. 910 RETE 1600 X 2100

VARIANTI GIROLETTO OPTIONAL

B C D E F G H I L

LETTO CASPER



MISURE DISPONIBILI (mm)

L. 890 P. 1990 H. 910 RETE 800 X 1900
 L. 990 P. 2040 H. 910 RETE 900 X 1950
 L. 1290 P. 2040 H. 910 RETE 1200 X 1950

L. 990 P. 2190 H. 910 RETE 900 X 2100
 L. 1290 P. 2190 H. 910 RETE 1200 X 2100

VARIANTI GIROLETTO OPTIONAL

B C D E F G H I L



F

Giroletto con pediera e piedini Lateral



G

Giroletto con piedini in polimero trasp.



H

Giroletto contenitore



I

Giroletto con cassettoni estraibili



L

Giroletto con rete estraibile

LETTI A TERRA

LETTO **TIONE**



MISURE DISPONIBILI (mm)

L. 890 P. 1990 H. 910 RETE 800 X 1900
 L. 990 P. 2040 H. 910 RETE 900 X 1950
 L. 1290 P. 2040 H. 910 RETE 1200 X 1950

L. 990 P. 2190 H. 910 RETE 900 X 2100
 L. 1290 P. 2190 H. 910 RETE 1200 X 2100

VARIANTI GIROLETTO OPTIONAL

A B C D E F G H I L

LETTO **CORE**



MISURE DISPONIBILI (mm)

L. 890 P. 1990 H. 910 RETE 800 X 1900
 L. 990 P. 2040 H. 910 RETE 900 X 1950
 L. 1290 P. 2040 H. 910 RETE 1200 X 1950

L. 990 P. 2190 H. 910 RETE 900 X 2100
 L. 1290 P. 2190 H. 910 RETE 1200 X 2100

VARIANTI GIROLETTO OPTIONAL

A C D E F G H I L

LETTO **ELICE**



MISURE DISPONIBILI (mm)

L. 890 P. 2070 H. 910 RETE 800 X 1900
 L. 990 P. 2120 H. 910 RETE 900 X 1950
 L. 1290 P. 2120 H. 910 RETE 1200 X 1950
 L. 1690 P. 2120 H. 910 RETE 1600 X 1950

L. 990 P. 2270 H. 910 RETE 900 X 2100
 L. 1290 P. 2270 H. 910 RETE 1200 X 2100
 L. 1690 P. 2270 H. 910 RETE 1600 X 2100

VARIANTI GIROLETTO OPTIONAL

A C D E F G H I L

VARIANTI GIROLETTO OPTIONAL



A

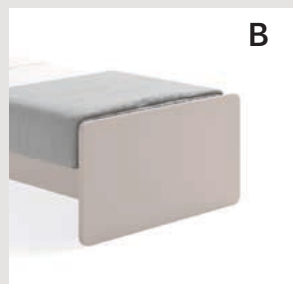

B



C



D



E

Pediera a terra con angoli 90°

Pediera a terra con angoli arrotondati

Giroletto con piedini legno 50x50 mm

Giroletto con piedini Kios 20x20 mm

Giroletto con piedini Lateral

LETTO CALE



MISURE DISPONIBILI (mm)

L. 890 P. 2070 H. 910 RETE 800 X 1900
 L. 990 P. 2120 H. 910 RETE 900 X 1950
 L. 1290 P. 2120 H. 910 RETE 1200 X 1950
 L. 1690 P. 2120 H. 910 RETE 1600 X 1950

L. 990 P. 2270 H. 910 RETE 900 X 2100
 L. 1290 P. 2270 H. 910 RETE 1200 X 2100
 L. 1690 P. 2270 H. 910 RETE 1600 X 2100

VARIANTI GIROLETTO OPTIONAL

B C D E F G H I L

LETTO CALE IMBOTTITO



MISURE DISPONIBILI (mm)

L. 890 P. 2070 H. 910 RETE 800 X 1900
 L. 990 P. 2120 H. 910 RETE 900 X 1950
 L. 1290 P. 2120 H. 910 RETE 1200 X 1950
 L. 1690 P. 2120 H. 910 RETE 1600 X 1950

L. 990 P. 2270 H. 910 RETE 900 X 2100
 L. 1290 P. 2270 H. 910 RETE 1200 X 2100
 L. 1690 P. 2270 H. 910 RETE 1600 X 2100

VARIANTI GIROLETTO OPTIONAL

B C D E F G H I L

LETTO ELARA



MISURE DISPONIBILI (mm)

L. 890 P. 2070 H. 910 RETE 800 X 1900
 L. 990 P. 2120 H. 910 RETE 900 X 1950
 L. 1290 P. 2120 H. 910 RETE 1200 X 1950
 L. 1690 P. 2120 H. 910 RETE 1600 X 1950

L. 990 P. 2270 H. 910 RETE 900 X 2100
 L. 1290 P. 2270 H. 910 RETE 1200 X 2100
 L. 1690 P. 2270 H. 910 RETE 1600 X 2100

VARIANTI GIROLETTO OPTIONAL

A B C D E F G H I L



Giroletto con pediera e piedini Lateral



Giroletto con piedini in polimero trasp.



Giroletto contenitore



Giroletto con cassettoni estraibili



Giroletto con rete estraibile

LETTI A TERRA

LETTO ELARA IMBOTTITO



MISURE DISPONIBILI (mm)

L. 890 P. 2070 H. 910 RETE 800 X 1900
 L. 990 P. 2120 H. 910 RETE 900 X 1950
 L. 1290 P. 2120 H. 910 RETE 1200 X 1950
 L. 1690 P. 2120 H. 910 RETE 1600 X 1950

L. 990 P. 2270 H. 910 RETE 900 X 2100
 L. 1290 P. 2270 H. 910 RETE 1200 X 2100
 L. 1690 P. 2270 H. 910 RETE 1600 X 2100

VARIANTI GIROLETTO OPTIONAL

B C D E F G H I L

LETTO TERRY



MISURE DISPONIBILI (mm)

L. 890 P. 1990 H. 910 RETE 800 X 1900
 L. 990 P. 2040 H. 910 RETE 900 X 1950
 L. 1290 P. 2040 H. 910 RETE 1200 X 1950

L. 990 P. 2190 H. 910 RETE 900 X 2100
 L. 1290 P. 2190 H. 910 RETE 1200 X 2100

VARIANTI GIROLETTO OPTIONAL

B C D E F G H I L

LETTO TERRY IMBOTTITO



MISURE DISPONIBILI (mm)

L. 890 P. 1990 H. 910 RETE 800 X 1900
 L. 990 P. 2040 H. 910 RETE 900 X 1950
 L. 1290 P. 2040 H. 910 RETE 1200 X 1950

L. 990 P. 2190 H. 910 RETE 900 X 2100
 L. 1290 P. 2190 H. 910 RETE 1200 X 2100

VARIANTI GIROLETTO OPTIONAL

B C D E F G H I L

VARIANTI GIROLETTO OPTIONAL



A

Pediera a terra con angoli 90°

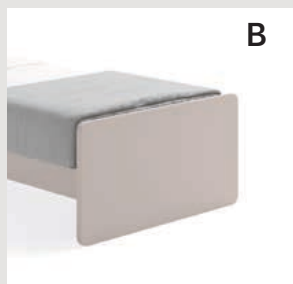

B

Pediera a terra con angoli arrotondati



C

Giroletto con piedini legno 50x50 mm



D

Giroletto con piedini Kios 20x20 mm



E

Giroletto con piedini Lateral

LETTO ARCHE'



MISURE DISPONIBILI (mm)

L. 990 P. 2130 H. 950 RETE 900 X 1950
L. 1290 P. 2130 H. 950 RETE 1200 X 1950

L. 990 P. 2180 H. 950 RETE 900 X 2100
L. 1290 P. 2180 H. 950 RETE 1200 X 2100

VARIANTI GIROLETTO OPTIONAL

C D E F G

LETTO ARCHE' IMBOTTITO



MISURE DISPONIBILI (mm)

L. 990 P. 2130 H. 950 RETE 900 X 1950
L. 1290 P. 2130 H. 950 RETE 1200 X 1950

L. 990 P. 2180 H. 950 RETE 900 X 2100
L. 1290 P. 2180 H. 950 RETE 1200 X 2100

VARIANTI GIROLETTO OPTIONAL

C D E F G

LETTO TONGA



MISURE DISPONIBILI (mm)

L. 990 P. 2130 H. 930 RETE 900 X 1950
L. 1290 P. 2130 H. 930 RETE 1200 X 1950
L. 1690 P. 2130 H. 930 RETE 1600 X 1950

L. 990 P. 2180 H. 930 RETE 900 X 2100
L. 1290 P. 2180 H. 930 RETE 1200 X 2100
L. 1690 P. 2180 H. 930 RETE 1600 X 2100

VARIANTI GIROLETTO OPTIONAL

B C D E F G



Giroletto con pediera e piedini Lateral



Giroletto con piedini in polimero trasp.



Giroletto contenitore



Giroletto con cassettoni estraibili



Giroletto con rete estraibile

LETTI A TERRA

LETTO PUZZLE CON PIANALE



MISURE DISPONIBILI (mm)

L. 990 P. 2060 H. 890
L. 1290 P. 2080 H. 890

VARIANTI GIROLETTO OPTIONAL
A C E H I L M N O P

LETTO KARTA CON PIANALE



MISURE DISPONIBILI (mm)

L. 980 P. 2080 H. 755
L. 1280 P. 2080 H. 755

VARIANTI GIROLETTO OPTIONAL
M N O P

LETTO KARTA CON GIROLETTO



MISURE DISPONIBILI (mm)

L. 1030 P. 2080 H. 755 RETE 900 X 1950
L. 1330 P. 2080 H. 755 RETE 1200 X 1950
L. 1730 P. 2080 H. 755 RETE 1600 X 1950

VARIANTI GIROLETTO OPTIONAL
H

VARIANTI GIROLETTO OPTIONAL

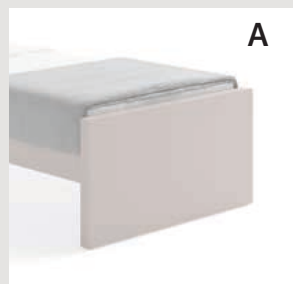

Pediera a terra con angoli 90°



Giroletto con piedini legno 50x50 mm



Giroletto con piedini Lateral



Giroletto contenitore



Giroletto con cassettoni estraibili

LETTO KARTA CON TESTIERA IMBOTTITA



MISURE DISPONIBILI (mm)

L. 1130 P. 2130 H. 830
 L. 1430 P. 2130 H. 830
 L. 1830 P. 2130 H. 830

LETTO KARTA SCORREVOLE



MISURE DISPONIBILI (mm)

L. 982 P. 2040 H. 800

LETTO KARTA SCORREVOLE CON TESTIERA IMBOTTITA



MISURE DISPONIBILI (mm)

L. 1000 P. 2040 H. 830

VARIANTI GIROLETTO OPTIONAL



L

Giroletto con rete estraibile



M

Pianale con piedini 40 x 40



N

Pianale con piedini Slim



O

Pianale con gamba Slitta



P

Pianale con piedini in polimero trasp.

LETTI A TERRA

LETTO **FRESH**



MISURE DISPONIBILI (mm)

L. 990 P. 2040 H. 910 RETE 900X1950
L. 1290 P. 2040 H. 910 RETE 1200X1950
L. 1690 P. 2040 H. 910 RETE 1600X1950

LETTO **LULLY**



MISURE DISPONIBILI (mm)

L. 990 P. 2260 H. 910 RETE 900 X 2000

LETTO **SIPARIO**



MISURE DISPONIBILI (mm) / DIMENSIONS AVAILABLE (mm)

L. 1040 P. 2060 H. 900 RETE / BEDSPRING 900 X 1950

VARIANTI GIROLETTO OPTIONAL / OPTIONAL BEDRINGS

A H I L R

VARIANTI GIROLETTO OPTIONAL / OPTIONALS

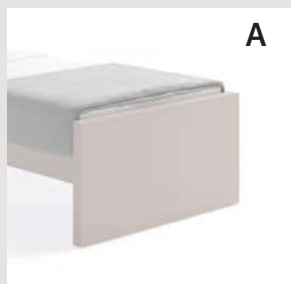

A

Pianale a terra con angoli 90°



H

Giroletto contenitore



I

Giroletto con cassettoni estraibili



L

Giroletto con rete estraibile



Q

Giroletto imbottito con piedini legno

LETTO SIPARIO TESTIERA IMBOTTITA



MISURE DISPONIBILI (mm)

L. 1040 P. 2060 H. 900 RETE 900 X 1950

VARIANTI GIROLETTO OPTIONAL

A H I L Q R S

LETTO SIPARIO CON 1 ALETTA



MISURE DISPONIBILI (mm)

L. 1440 P. 2060 H. 900 RETE 900 X 1950

ALETTA:

L. 400 H. 900 LEGNO

L. 400 H. 900 IMBOTTITA

L. 400 H. 900 IMBOTTITA CON CINGHIA

VARIANTI GIROLETTO OPTIONAL

A H I L Q R S

LETTO SIPARIO CON 2 ALETTE



MISURE DISPONIBILI (mm)

L. 1840 P. 2060 H. 900 RETE 900 X 1950

ALETTE:

L. 400 H. 900 LEGNO

L. 400 H. 900 IMBOTTITA

L. 400 H. 900 IMBOTTITA CON CINGHIA

VARIANTI GIROLETTO OPTIONAL

A H I L Q R S



Giroletto contenitore imbottito



Giroletto con piedini in legno

LETTI A TERRA

SISTEMA WALL PANNELLO

LIBERAMENTE ACCOSTABILI CON ALTEZZE DA TERRA A PIACERE.
ANCHE ALTERNATI CON I PANNELLI WALL IMBOTTITI.

AL SISTEMA WALL POSSONO ESSERE ACCOSTATI TUTTI I GIROLETTI
E LETTI ALLA TURCA.



L. 450	L. 600	L. 900	L. 450	L. 450
H. 736	H. 736	H. 736	H. 900	H. 900
P. 50	P. 50	P. 50	P. 300	P. 50

SISTEMA WALL PANNELLO IMBOTTITO

LIBERAMENTE ACCOSTABILI CON ALTEZZE DA TERRA A PIACERE.
ANCHE ALTERNATI CON I PANNELLI WALL IN MELAMINICO/LACCATI.

AL SISTEMA WALL POSSONO ESSERE ACCOSTATI TUTTI I GIROLETTI,
LETTI ALLA TURCA, DIVANI LETTO E LOBBY.

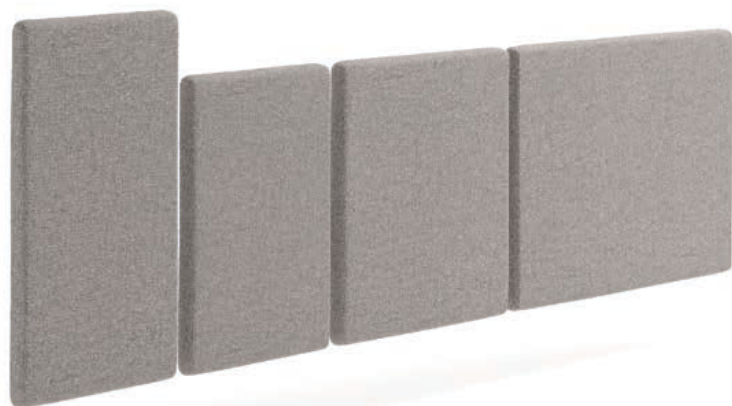

L. 450	L. 450	L. 600	L. 900
H. 900	H. 736	H. 736	H. 736
P. 50	P. 50	P. 50	P. 50

GIROLETTO CON PIEDINI IN POLIMERO



MISURE DISPONIBILI (mm)

L. 890 P. 1900 H. 450 RETE 800 X 1900
 L. 990 P. 2040 H. 450 RETE 900 X 1950
 L. 1290 P. 2040 H. 450 RETE 1200 X 1950
 L. 1690 P. 2040 H. 450 RETE 1600 X 1950

L. 990 P. 2190 H. 450 RETE 900 X 2100
 L. 1290 P. 2190 H. 450 RETE 1200 X 2100
 L. 1690 P. 2190 H. 450 RETE 1600 X 2100

LONGONE H. 110 MM
 ALTEZZA RETE DA TERRA 350 MM

GIROLETTO CON PIEDINI LATERAL



MISURE DISPONIBILI (mm)

L. 890 P. 1900 H. 450 RETE 800 X 1900
 L. 990 P. 2040 H. 450 RETE 900 X 1950
 L. 1290 P. 2040 H. 450 RETE 1200 X 1950
 L. 1690 P. 2040 H. 450 RETE 1600 X 1950

L. 990 P. 2190 H. 450 RETE 900 X 2100
 L. 1290 P. 2190 H. 450 RETE 1200 X 2100
 L. 1690 P. 2190 H. 450 RETE 1600 X 2100

LONGONE H. 110 MM
 ALTEZZA RETE DA TERRA 350 MM

GIROLETTO SU RUOTE



MISURE DISPONIBILI (mm)

L. 890 P. 1900 H. 450 RETE 800 X 1900
 L. 990 P. 2040 H. 450 RETE 900 X 1950
 L. 1290 P. 2040 H. 450 RETE 1200 X 1950
 L. 1690 P. 2040 H. 450 RETE 1600 X 1950

L. 990 P. 2190 H. 450 RETE 900 X 2100
 L. 1290 P. 2190 H. 450 RETE 1200 X 2100
 L. 1690 P. 2190 H. 450 RETE 1600 X 2100

LONGONE H. 110 MM
 ALTEZZA RETE DA TERRA 350 MM

GIROLETTO CON CONTENITORE



MISURE DISPONIBILI (mm)

L. 890 P. 1900 H. 450 RETE 800 X 1900
 L. 990 P. 2040 H. 450 RETE 900 X 1950
 L. 1290 P. 2040 H. 450 RETE 1200 X 1950
 L. 1690 P. 2040 H. 450 RETE 1600 X 1950

L. 990 P. 2190 H. 450 RETE 900 X 2100
 L. 1290 P. 2190 H. 450 RETE 1200 X 2100
 L. 1690 P. 2190 H. 450 RETE 1600 X 2100

LONGONE H. 110 MM
 ALTEZZA RETE DA TERRA 350 MM

LETTI A TERRA

LETTO DOLL IMBOTTITO



MISURE DISPONIBILI (mm)

L. 1180 P. 2270 H. 960 RETE 900 X 1950
L. 1430 P. 2270 H. 960 RETE 1200 X 1950
L. 1830 P. 2270 H. 960 RETE 1600 X 1950

VARIANTI GIROLETTO OPTIONAL

Giroletto con box contenitore

LETTO SLITTA IMBOTTITO



MISURE DISPONIBILI (mm)

L. 1040 P. 2200 H. 900 RETE 900 X 1950
L. 1340 P. 2200 H. 900 RETE 1200 X 1950
L. 1740 P. 2200 H. 900 RETE 1600 X 1950

VARIANTI GIROLETTO OPTIONAL

Bordino Bianco in contrasto Tessuti ed Ecopelli

LETTO QUADRO



MISURE DISPONIBILI (mm)

L. 1070 P. 2200 H. 830 RETE 900 X 1950
L. 1370 P. 2200 H. 830 RETE 1200 X 1950
L. 1770 P. 2200 H. 830 RETE 1600 X 1950

VARIANTI GIROLETTO OPTIONAL

Varianti ricamo "punto cavallo" in diversi colori
Giroletto con box contenitore

Bordino in contrasto letto Slitta

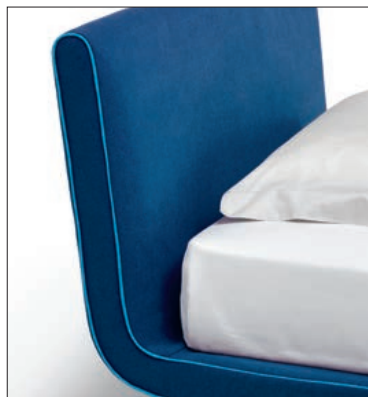

Ricamo "punto cavallo" letto Quadro





LETTI A TERRA

LETTO **LESS IMBOTTITO** GIROLETTO H 300



MISURE DISPONIBILI (mm)

L. 940 P. 2070 H. 940 RETE 800 X 1900
L. 1040 P. 2120 H. 940 RETE 900 X 1950
L. 1340 P. 2120 H. 940 RETE 1200 X 1950
L. 1740 P. 2120 H. 940 RETE 1600 X 1950

GIROLETTO H. 300 MM
ALTEZZA RETE DA TERRA 300 MM

VARIANTI GIROLETTO OPTIONAL
GIROLETTO CON BOX CONTENITORE

LETTO **LESS IMBOTTITO** GIROLETTO H 160



MISURE DISPONIBILI (mm)

L. 940 P. 2070 H. 940 RETE 800 X 1900
L. 1040 P. 2120 H. 940 RETE 900 X 1950
L. 1340 P. 2120 H. 940 RETE 1200 X 1950
L. 1740 P. 2120 H. 940 RETE 1600 X 1950

GIROLETTO H. 160 MM
ALTEZZA RETE DA TERRA 300 MM

LETTO **LESS IMBOTTITO** TURCA H 300



MISURE DISPONIBILI (mm)

L. 940 P. 2070 H. 940 RETE 800 X 1900
L. 1040 P. 2120 H. 940 RETE 900 X 1950
L. 1340 P. 2120 H. 940 RETE 1200 X 1950
L. 1740 P. 2120 H. 940 RETE 1600 X 1950

GIROLETTO H. 300 MM
ALTEZZA RETE DA TERRA 300 MM

VARIANTI GIROLETTO OPTIONAL
GIROLETTO CON BOX CONTENITORE

LETTO **LESS IMBOTTITO** TURCA H 160



MISURE DISPONIBILI (mm)

L. 940 P. 2070 H. 940 RETE 800 X 1900
L. 1040 P. 2120 H. 940 RETE 900 X 1950
L. 1340 P. 2120 H. 940 RETE 1200 X 1950
L. 1740 P. 2120 H. 940 RETE 1600 X 1950

GIROLETTO H. 160 MM
ALTEZZA RETE DA TERRA 300 MM

LETTO **BOTTON** GIROLETTO LEGNO H 120



MISURE DISPONIBILI (mm)

L. 980 P. 2130 H. 920 RETE 900 X 1950
 L. 1280 P. 2130 H. 920 RETE 1200 X 1950
 L. 1680 P. 2130 H. 920 RETE 1600 X 1950

GIROLETTO H. 120 MM

VARIANTI GIROLETTO OPTIONAL



LETTO **BOTTON** GIROLETTO LEGNO H 350



MISURE DISPONIBILI (mm)

L. 980 P. 2130 H. 920 RETE 900 X 1950
 L. 1280 P. 2130 H. 920 RETE 1200 X 1950
 L. 1680 P. 2130 H. 920 RETE 1600 X 1950

GIROLETTO H. 350 MM

VARIANTI GIROLETTO OPTIONAL GIROLETTO CON BOX CONTENITORE

LETTO **BOTTON** IMBOTTITO GIROLETTO H 120



MISURE DISPONIBILI (mm)

L. 980 P. 2130 H. 920 RETE 900 X 1950
 L. 1280 P. 2130 H. 920 RETE 1200 X 1950
 L. 1680 P. 2130 H. 920 RETE 1600 X 1950

GIROLETTO H. 120 MM

VARIANTI GIROLETTO OPTIONAL



LETTO **BOTTON** IMBOTTITO GIROLETTO H 350



MISURE DISPONIBILI (mm)

L. 980 P. 2130 H. 920 RETE 900 X 1950
 L. 1280 P. 2130 H. 920 RETE 1200 X 1950
 L. 1680 P. 2130 H. 920 RETE 1600 X 1950

GIROLETTO H. 350 MM

VARIANTI GIROLETTO OPTIONAL GIROLETTO CON BOX CONTENITORE

DIVANI LETTO

DIVANO LETTO IMBOTTITO **LESS**



MISURE DISPONIBILI (mm)

L. 2040 P. 900 H. 860 RETE 800 X 1900
L. 2040 P. 1000 H. 860 RETE 900 X 1900

VARIANTI OPTIONAL
CON BOX CONTENITORE

DIVANO LETTO IMBOTTITO **LESS DX - SX**



MISURE DISPONIBILI (mm)

L. 2040 P. 900 H. 860 RETE 800 X 1900
L. 2040 P. 1000 H. 860 RETE 900 X 1900

VARIANTI OPTIONAL
CON BOX CONTENITORE

DIVANO LETTO IMBOTTITO **HINGE**



MISURE DISPONIBILI (mm)

L. 2040 P. 930 H. 700 RETE 800 X 1900
L. 2040 P. 1030 H. 700 RETE 900 X 1900

VARIANTI OPTIONAL
CON BOX CONTENITORE

DIVANO LETTO **APOLLO**



MISURE DISPONIBILI (mm)

L. 2060 P. 880 H. 630 RETE 800 X 1950
L. 2060 P. 980 H. 630 RETE 900 X 1950

VARIANTI OPTIONAL
SECONDO LETTO ESTRAIBILE
CASSETTONI ESTRAIBILI
VANO CONTENITORE

TURCA **BASE**



MISURE DISPONIBILI (mm)

L. 890 P. 190 H. 450 RETE 800 X 1900
 L. 990 P. 2040 H. 450 RETE 900 X 1950
 L. 1290 P. 2040 H. 450 RETE 1200 X 1950
 L. 1690 P. 2040 H. 450 RETE 1600 X 1950

L. 990 P. 2190 H. 450 RETE 900 X 2100
 L. 1290 P. 2190 H. 450 RETE 1200 X 2100
 L. 1690 P. 2190 H. 450 RETE 1600 X 2100

TURCA **SAGOMATO**



MISURE DISPONIBILI (mm)

L. 890 P. 190 H. 450 RETE 800 X 1900
 L. 990 P. 2040 H. 450 RETE 900 X 1950
 L. 1290 P. 2040 H. 450 RETE 1200 X 1950
 L. 1690 P. 2040 H. 450 RETE 1600 X 1950

L. 990 P. 2190 H. 450 RETE 900 X 2100
 L. 1290 P. 2190 H. 450 RETE 1200 X 2100
 L. 1690 P. 2190 H. 450 RETE 1600 X 2100

TURCA **TIONE**



MISURE DISPONIBILI (mm)

L. 890 P. 190 H. 450 RETE 800 X 1900
 L. 990 P. 2040 H. 450 RETE 900 X 1950
 L. 1290 P. 2040 H. 450 RETE 1200 X 1950
 L. 1690 P. 2040 H. 450 RETE 1600 X 1950

L. 990 P. 2190 H. 450 RETE 900 X 2100
 L. 1290 P. 2190 H. 450 RETE 1200 X 2100
 L. 1690 P. 2190 H. 450 RETE 1600 X 2100



XL SISTEMA LETTI - MATERASSO IN APPOGGIO SU CASSETTONI CON 8 FORI DI AERAZIONE



XL 01
Fianco sp. 50 / 30 mm
L. 2030 P. 1000 H. 705
L. 2050 P. 1000 H. 705



XL 02
Fianco sp. 50 / 30 mm
L. 2060 P. 1000 H. 705
L. 2100 P. 1000 H. 705



XL 03
Fianco a giorno 250 mm
L. 2280 P. 1000 H. 705
L. 2300 P. 1000 H. 705



XL 04
Fianco sp. 50 / 30 mm
L. 2630 P. 2050 H. 705
L. 2650 P. 2050 H. 705



XL 05
Fianco a giorno L 250 mm
L. 2850 P. 1000 H. 705



XL 06
Fianco sp. 50 / 30 mm
L. 3050 P. 2000 H. 705
L. 3080 P. 2000 H. 705



XL 07
L. 3000 P. 3050 H. 705

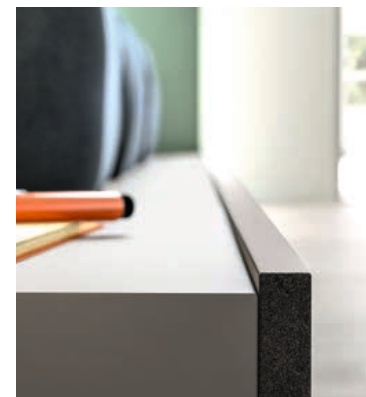

PANNELLATURA **CLOUD** IMBOTTITA



L. 450 H. 450 SP. 40



L. 941 H. 450 SP. 40



L. 486 H. 570 SP. 40

TURCHE - LETTI - DIVANI LETTO IMBOTTITI SMART

GIROLETTO IMBOTTITO ESTRAIBILE / BOX LATERALE

MISURE (mm)

L. 900 P. 2020 H. 340 RETE 800 X 1900



VARIANTI OPTIONAL

SECONDA RETE ESTRAIBILE
VANO CONTENITORE SOTTORETE

LETTO IMBOTTITO ESTRAIBILE / BOX LATERALE

MISURE (mm)

L. 900 P. 2020 H. 820 RETE 800 X 1900



VARIANTI OPTIONAL

SECONDA RETE ESTRAIBILE
VANO CONTENITORE SOTTORETE

LETTO IMBOTTITO ESTRAIBILE / BOX LATERALE

MISURE (mm)

L. 900 P. 2020 H. 820 RETE 800 X 1900



VARIANTI OPTIONAL

SECONDA RETE ESTRAIBILE
VANO CONTENITORE SOTTORETE

LETTO IMBOTTITO ESTRAIBILE / BOX LATERALE

MISURE (mm)

L. 900 P. 2020 H. 820 RETE 800 X 1900



VARIANTI OPTIONAL

SECONDA RETE ESTRAIBILE
VANO CONTENITORE SOTTORETE

TURCHE - LETTI - DIVANI LETTO IMBOTTITI SMART

LETTO IMBOTTITO ESTRAIBILE / BOX LATERALE

MISURE (mm)

L. 900 P. 2020 H. 820 RETE 800 X 1900



VARIANTI OPTIONAL

SECONDA RETE ESTRAIBILE

VANO CONTENITORE SOTTORETE

LETTO IMBOTTITO ESTRAIBILE / BOX LATERALE

MISURE (mm)

L. 900 P. 2020 H. 820 RETE 800 X 1900



VARIANTI OPTIONAL

SECONDA RETE ESTRAIBILE

VANO CONTENITORE SOTTORETE

LETTI POLIFUNZIONALI

LETTO LOBBY ESTRAIBILE



MISURE (mm)

LETTO INFERIORE ESTRAIBILE

L. 1990 P. 890 H. 513 RETE 800 X 1900

L. 1990 P. 990 H. 513 RETE 900 X 1900

VARIANTI OPTIONAL

- LETTO ESTRAIBILE
- CASSETTONI ESTRAIBILI

LETTO LOBBY BASSO / ESTRAIBILE



MISURE (mm)

LETTO SUPERIORE FISSO

L. 2060 P. 890 H. 1030 RETE 800 X 1950

L. 2060 P. 990 H. 1030 RETE 900 X 1950

LETTO INFERIORE ESTRAIBILE

L. 1990 P. 890 H. 513 RETE 800 X 1900

L. 1990 P. 990 H. 513 RETE 900 X 1900

LETTO LOBBY ALTO / ESTRAIBILE



MISURE (mm)

LETTO SUPERIORE

L. 2060 P. 890 H. 1256 RETE 800X1950

L. 2060 P. 990 H. 1256 RETE 900X1950

LETTO INFERIORE ESTRAIBILE

L. 1990 P. 890 H. 513 RETE 800X1900

L. 1990 P. 990 H. 513 RETE 900X1900

LETTO LOBBY ALTO / BASSO / ESTARIBILE



MISURE (mm)

LETTO SUPERIORE

L. 2130 P. 890 H. 1260 RETE 800X1950

L. 2130 P. 990 H. 1260 RETE 900X1950

LETTO BASSO

L. 2060 P. 890 H. 1030 RETE 800X1950

L. 2060 P. 990 H. 1030 RETE 900X1950

LETTO INFERIORE ESTRAIBILE

L. 1990 P. 890 H. 513 RETE 800X1900

L. 1990 P. 990 H. 513 RETE 900X1900

LETTO LOBBY ALTO CON SCRITTOIO / ESTRAIBILE



MISURE (mm)

LETTO SUPERIORE

L. 2060 P. 890 H. 1256 RETE 800X1950

L. 2060 P. 990 H. 1256 RETE 900X1950

LETTO INFERIORE ESTRAIBILE

L. 1990 P. 890 H. 513 RETE 800X1900

L. 1990 P. 990 H. 513 RETE 900X1900

LETTO LOBBY CORNER CON RETE RIALZABILE



MISURE (mm)

L. 2060 P. 990 H. 1030 RETE 900X1900

DX-SX

CON RETE RIALZABILE E VANO SOTTORETE

LETTO LOBBY CORNER CON RETE RIALZABILE



MISURE (mm)

L. 2060 P. 990 H. 1030 RETE 900 X 1900

DX-SX

CON RETE RIALZABILE E VANO SOTTORETE

LETTO LOBBY BOX



MISURE (mm)

LETTO ALTO CON 6 CASSETTI

L. 2060 P. 990 H. 1030 RETE 900 X 1950

LETTI POLIFUNZIONALI

LETTO LOBBY BOX



MISURE (mm)

LETTO BASSO CON 4 CASSETTI
L. 2060 P. 990 H. 840 RETE 900 X 1950

LETTO LOBBY BOX



MISURE (mm)

LETTO BASSO CON 2 CESTONI
L. 2060 P. 990 H. 840 RETE 900 X 1950

LETTO LOBBY BOX



MISURE (mm)

LETTO BASSO CON RETE ESTRAIBILE
L. 2060 P. 990 H. 840 RETE 900 X 1950

FISSO O SU RUOTE

LETTO LOBBY BOX



MISURE (mm)

LETTO ALTO CON 2 CASSETTI + 2 CESTONI
L. 2060 P. 990 H. 1030 RETE 900 X 1950

LETTO LOBBY BOX



MISURE (mm)

LETTO ALTO CON 2 CASSETTI E RETE ESTRAIBILE
L. 2060 P. 990 H. 1030 RETE 900 X 1950

FISSO O SU RUOTE



Un vasto assortimento di letti a castello, tutti integrabili con le modularità e gli elementi di arredo Start.20.20, accessori e varianti per soddisfare ogni tipo di esigenza estetica, funzionale e salvaspazio.

BUNK BEDS

A wide assortment of bunk beds, all integrable with modularity and design elements of Start.20.20, accessories and variants to suit every type of aesthetic, functional and space requirements.

LETTI A CASTELLO





LETTI A CASTELLO

CASTELLO CON SALITA POSTERIORE



MISURE (mm)

L. 2060 P. 1360 / 1460 H. 1760 FIANCHI SP. 30
L. 2100 P. 1360 / 1460 H. 1760 FIANCHI SP. 50

CASTELLO CON SALITA POSTERIORE



MISURE (mm)

L. 2060 P. 1360 / 1460 H. 1760 FIANCHI SP. 30
L. 2100 P. 1360 / 1460 H. 1760 FIANCHI SP. 50

CASTELLO CON SCRITTOIO E SALITA POSTERIORE



MISURE (mm)

L. 2425 P. 1668 / 1768 H. 1760 FIANCHI SP. 30
L. 2465 P. 1668 / 1768 H. 1760 FIANCHI SP. 50

CASTELLO CON SCALETTA FRONTALE



MISURE (mm)

L. 2060 P. 890 / 990 H. 1760 FIANCHI SP. 30
L. 2100 P. 890 / 990 H. 1760 FIANCHI SP. 50

CASTELLO CON SCRITTOIO E SCALETTA FRONTALE



MISURE (mm)

L. 2410 P. 1218 / 1318 H.1760 FIANCHI SP. 30
 L. 2450 P. 1218 / 1318 H.1760 FIANCHI SP. 50

LETTO A SOPPALCO SLIDE



MISURE (mm)

L. 2110 P. 890 / 1350 H. 1760 FIANCHI SP. 30

PROTEZIONI PER LETTI ALTI

PROTEZIONE **BASE**

Melaminico / laccato

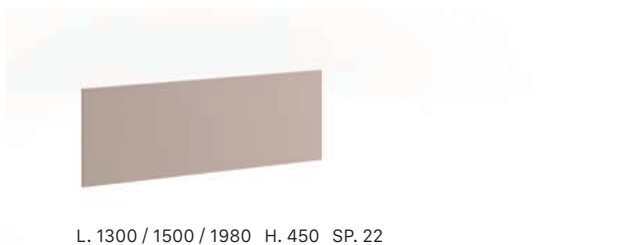

L. 1300 / 1500 / 1980 H. 450 SP. 22

PROTEZIONE **DAMA**

Melaminico / laccato



L. 450 H. 450 SP. 22



L. 941 H. 450 SP. 22



L. 486 H. 570 SP. 22

PROTEZIONE **DAMA IMBOTTITA**

Imbottito



L. 450 H. 450 SP. 40



L. 941 H. 450 SP. 40



L. 486 H. 570 SP. 40

Un infinito numero di possibilità compositive per la zona studio, grazie alla libertà di scelta di gambe per scrittoi, spessori e dimensioni, e anche forme e disegni personali di top e piani.

I casellari e le librerie sono gli accessori fondamentali per arredare la zona notte ma anche per creare innovative soluzioni per la zona studio o home-office, così come per gli spazi living delle zone giorno.

DESKS AND WALLBOXES

An infinite number of compositional possibilities for the studio area, thanks to the freedom to choose legs for writing, thickness and size, and also top and bottom personal shapes and designs.

Wallboxes and bookcases are the basic accessories to furnish the sleeping area but also to create innovative solutions for the studio or home office area, as well as living areas in daytime areas.

SCRITTOI E CASELLARI



CASELLARI

KIOS CASELLARIO

LIBRERIE IN METALLO BRUNITO

Dimensioni in mm



L. 600 P. 250 H. 368



L. 900 P. 250 H. 368



L. 600 P. 250 H. 552



L. 300 P. 250 H. 1104

GATE LIBRERIA - H 368 / P 250

LIBRERIA MODULARE - DX / SX

Dimensioni in mm



L. 450 DX



L. 600 DX



L. 900 DX



L. 1200 DX



L. 1500 DX

GATE LIBRERIA - H 1104 / P 250

LIBRERIA MODULARE - DX / SX

Dimensioni in mm



L. 450 DX



L. 600 DX



L. 900 DX



L. 1200 DX



L. 1500 DX





CROSS CASELLARIO

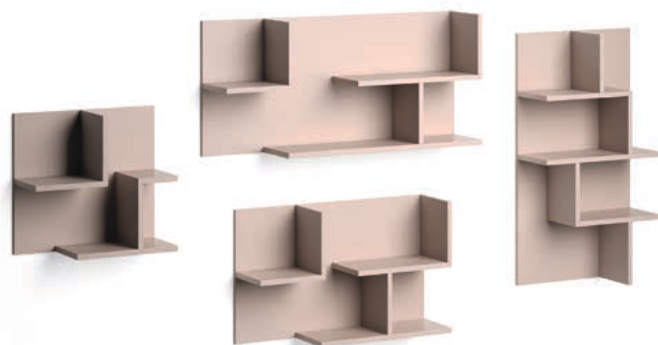

MISURE (mm)

L. 600	P.250	H. 552	DX-SX
L. 900	P.250	H. 552	DX-SX
L. 1200	P.250	H. 552	DX-SX
L. 600	P.250	H. 1104	DX-SX

FEDRA CASELLARIO

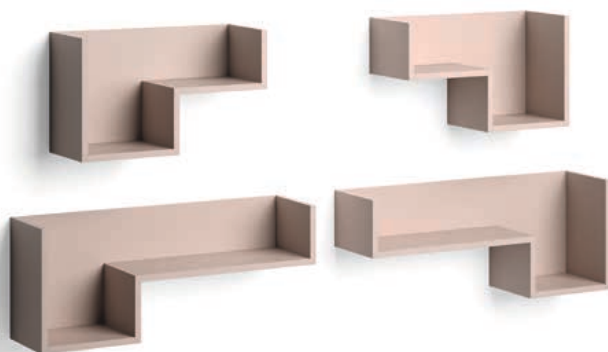

MISURE (mm)

L. 600	P. 250	H. 368 / 184	DX-SX
L. 900	P. 250	H. 368 / 184	DX-SX

TRIGO CASELLARIO

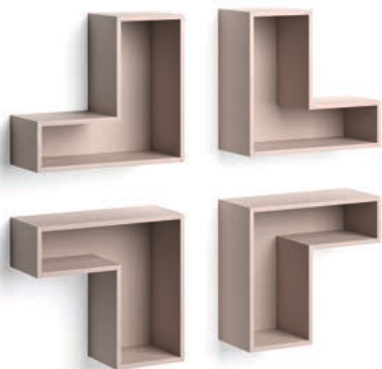

MISURE (mm)

L. 600	P. 250	H.552 / 184	DX-SX
--------	--------	-------------	-------

CASE CASELLARIO



MISURE (mm)

L. 300	P. 250	H. 368
L. 600	P.250	H. 368

CASELLARI

WOOD CASE CASELLARIO

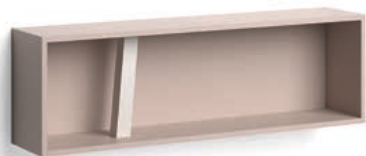

MISURE (mm)

L. 900 P. 250 H. 368 DX-SX
L. 1200 P. 250 H. 368 DX-SX
L. 1500 P. 250 H. 368

SNAKE LIBRERIA



MISURE (mm)

L. 900 P. 250 H. 1583
L. 1200 P. 250 H. 1583

SNAKE MENSOLA



MISURE (mm)

SPESSORE 30 / 50 P. 250

L. 600 L. 900 L. 1200 L. 1350 L. 1500
L. 1650 L. 1800 L. 2100 L. 2400 L. 2700

STAR MENSOLA



MISURE (mm)

SPESSORE 30 P. 250

L. 1200 L. 1350 L. 1500 L. 1800

MENSOLA CON SCHIENA



MISURE (mm)

SPESSORE 30 P. 250

L. 450 L. 600 L. 900 L. 1200 L. 1350 L. 1500



SCRITTOI

SCRITTOIO **LINEARE** SP. 50 / 30



MISURE (mm)

L. 1200	P. 608	H. 755
L. 1350	P. 608	H. 755
L. 1500	P. 608	H. 755
L. 1650	P. 608	H. 755
L. 1800	P. 608	H. 755

SCRITTOIO SP.50 CON GAMBA **SLITTA**



MISURE (mm)

L. 1200	P. 608	H. 755
L. 1350	P. 608	H. 755
L. 1500	P. 608	H. 755
L. 1650	P. 608	H. 755
L. 1800	P. 608	H. 755

SCRITTOIO SP. 50 / 30 CON GAMBE **KIOS**

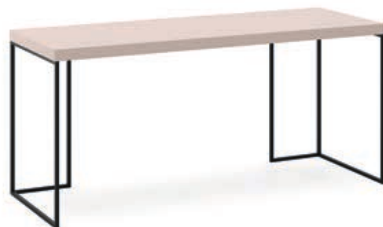

MISURE (mm)

L. 1200	P. 608	H. 755
L. 1350	P. 608	H. 755
L. 1500	P. 608	H. 755
L. 1650	P. 608	H. 755
L. 1800	P. 608	H. 755

SCRITTOIO IN APPOGGIO SP. 50 CON GAMBE **KIOS**



MISURE (mm)

L. 1200	P. 608	H. 755
L. 1350	P. 608	H. 755
L. 1500	P. 608	H. 755
L. 1650	P. 608	H. 755
L. 1800	P. 608	H. 755

SCRITTOIO **SOSPESO** SP. 50



MISURE (mm)

L. 900	P. 608	H. 368
L. 1200	P. 608	H. 368
L. 1350	P. 608	H. 368
L. 1500	P. 608	H. 368

SCRITTOIO SU RUOTE



MISURE (mm)

L. 1170	P. 608	H. 755
L. 1320	P. 608	H. 755
L. 1470	P. 608	H. 755

CONSOLLE SP. 50



MISURE (mm)

L. 1200	P. 608	H. 755
L. 1350	P. 608	H. 755
L. 1500	P. 608	H. 755
L. 1650	P. 608	H. 755
L. 1800	P. 608	H. 755

SCRITTOIO SP. 50 CON GAMBA **WOOD BRIDGE**



MISURE (mm)

L. 1200	P. 608	H. 755
L. 1350	P. 608	H. 755
L. 1500	P. 608	H. 755
L. 1650	P. 608	H. 755
L. 1800	P. 608	H. 755

SCRITTOI **SAGOMATI** SP. 30 / 50



MISURE (mm)

L. 1200	P. 608	H. 755
L. 1350	P. 608	H. 755
L. 1500	P. 608	H. 755
L. 1650	P. 608	H. 755
L. 1800	P. 608	H. 755

SCRITTOI

GAMBE PER SCRITTOI, PENISOLE E PIANI SGAOMATI



FIANCO SP. 30 - 50



FIANCO A "L" SP. 30 - 50



CASSETTIERA CON SUPPORTO GIREVOLE



LIBRERIA



DIAPASON



DIAPASON CON RUOTE

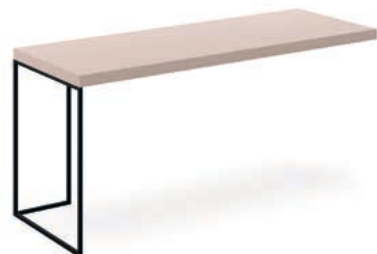

KIOS A "L"



KIOS APPOGGIO



SLITTA



SLIM



WOOD BRIDGE



QUADRO



CHARME



CILINDRO

SEDIE FISSE E SU RUOTE



WAVE SEDIA FISSA - BIANCO



ZEN FISSA - BIANCO / IMBOTTITA



PLAYA FISSA IN STIRENE FUMÉ



CORAL FISSA



CORAL RUOTE



POLKA FISSA



CORAL FISSA CON IMBOTTITURA



CORAL RUOTE IMBOTTITA



POLKA RUOTE



CORAL RUOTE CON BRACCIOLI



CORAL RUOTE CON BRACCIOLI IMBOTTITA



TRAFFIC IMBOTTITA



POUF QUADRATO IMBOTTITO



TRIPODE TAVOLINO

Cassettiere, comò, comodini e settimanili;
composizioni modulari infinite giocando con i
materiali e i colori.

Tutte le basi con cassetti sono disponibili
in melaminico o laccato, con i frontali dei
cassetti anche in essenza legno Rovere 74 o
Noce Canaletto.

NIGHTSTANDS AND DRAWER UNITS

Chest of drawers, dressers, bedside tables
and tall-boys; infinite modular compositions
by playing with materials and colors.

All bases with drawers are available in
melamine or lacquered, with drawer fronts
also in Rovere 74 or Noce canaletto.

COMODINI E CASSETTIERE



COMODINI E CASSETTIERE

CASSETTIERA 1 CASSETTO



MISURE (mm)

L. 450	P. 480	H. 222
L. 600	P. 480	H. 222
L. 900	P. 480	H. 222
L. 1200	P. 480	H. 222

CASSETTIERA 1 CASSETTO VANO GIORNO



MISURE (mm)

L. 450	P. 480	H. 406	CON RUOTE H. 436
L. 600	P. 480	H. 406	CON RUOTE H. 436
L. 900	P. 480	H. 406	CON RUOTE H. 436
L. 1200	P. 480	H. 406	CON RUOTE H. 436

CASSETTIERA 2 CASSETTI



MISURE (mm)

L. 450	P. 480	H. 406	CON RUOTE H. 436
L. 600	P. 480	H. 406	CON RUOTE H. 436
L. 900	P. 480	H. 406	CON RUOTE H. 436
L. 1200	P. 480	H. 406	CON RUOTE H. 436

CASSETTIERA 3 CASSETTI



MISURE (mm)

L. 450	P. 480	H. 590	CON RUOTE H. 620
L. 600	P. 480	H. 590	CON RUOTE H. 620
L. 900	P. 480	H. 590	CON RUOTE H. 620
L. 1200	P. 480	H. 590	CON RUOTE H. 620

CASSETTIERA 4 CASSETTI



MISURE (mm)

L. 450	P. 480	H. 774	CON RUOTE H. 804
L. 600	P. 480	H. 774	CON RUOTE H. 804
L. 900	P. 480	H. 774	CON RUOTE H. 804
L. 1200	P. 480	H. 774	CON RUOTE H. 804

CASSETTIERA 6 CASSETTI

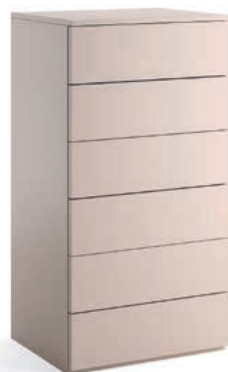

MISURE (mm)

L. 450	P. 480	H. 1142
L. 600	P. 480	H. 1142
L. 900	P. 480	H. 1142
L. 1200	P. 480	H. 1142

PANCA CON PORTABITI E CASSETTIERA



MISURE (mm)

L. 900	P. 480	H. 1202
CON CASSETTIERA DA 450 DX-SX		
L. 1050	P. 480	H. 1202
CON CASSETTIERA DA 600 DX-SX		



Più di 20 diverse tipologie di maniglie, pomoli, a tutta altezza e ad incasso tra cui scegliere. In metallo, legno o nel colore laccato preferito, la maniglia è un accessorio importante per completare ed arricchire con eleganza ogni composizione.

HANDLES

More than 20 different types of handles. With free placement, full-height, grooved and knobs to choose from. Made of metal, wood or lacquered color. The handle is an important accessory to complement and enrich each composition with elegance.

MANIGLIE

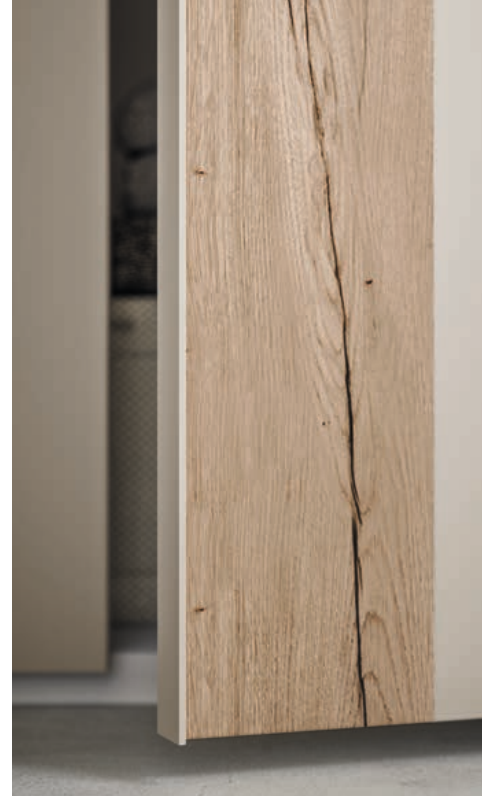



MANIGLIE

CLIO

C08

L. 138

TESA

C10 C11

L. 170 L. 330

DIDO

C02 C03

L. 180 L. 340

ARCO

C06 C07

L. 180 L. 350

CILINDRO

C20 C21

L. 220 L. 570

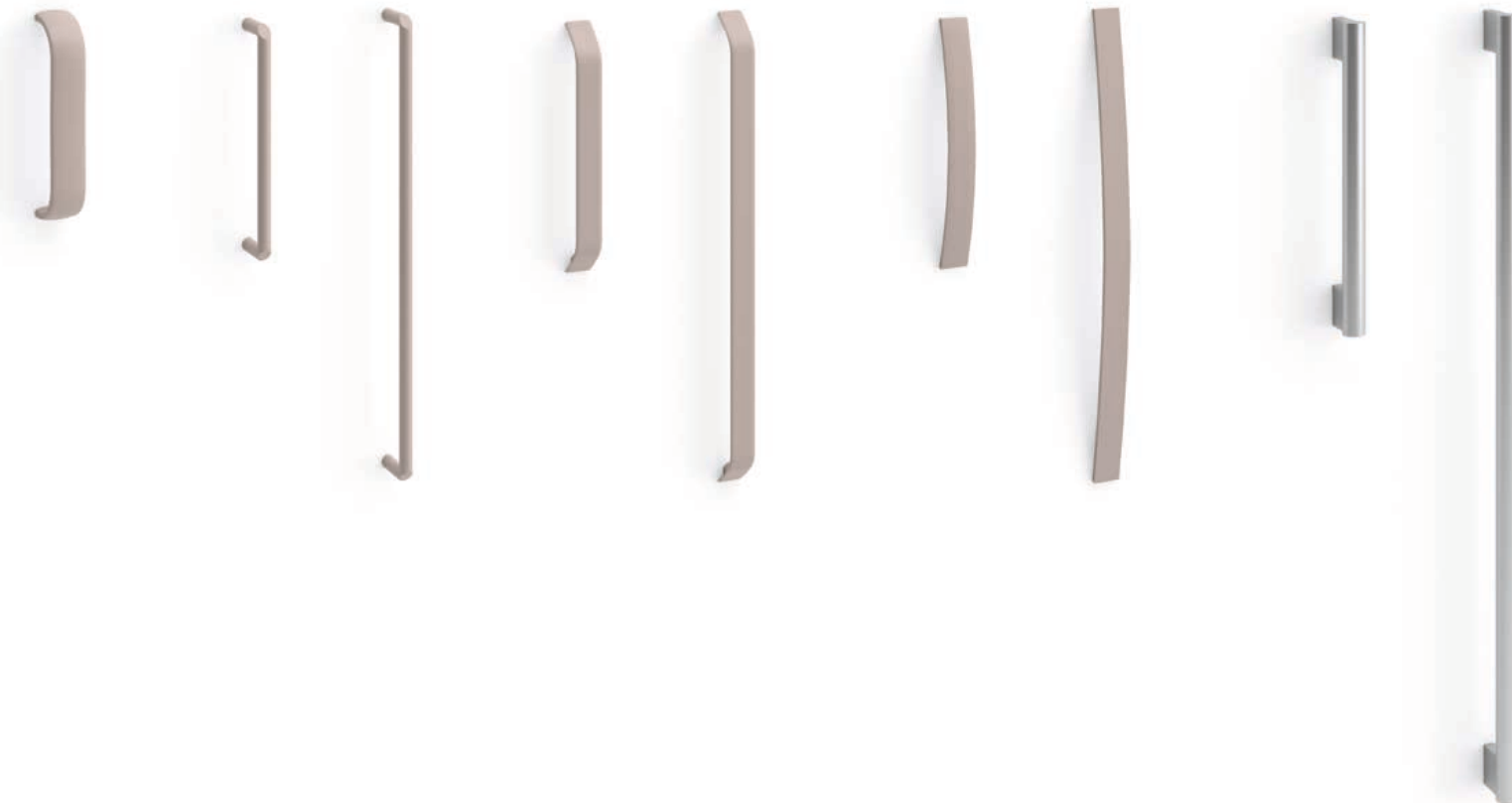

POMOLO

DOTTO C01

Ø 20



MANIGLIE AD INCASSO

C13

L. 115 H. 70



C16

L. 35 H. 80



C17

L. 35 H. 205



MANIGLIONE LACCATO

PARA C22

L. 120 H. 340



TENDER

C04 C05

L. 340 L. 1000

SIGMA

C14 C15

L. 220 L. 1200

STRIPE

C30 C31 C32 C33 C34

L. 50 L. 300 L. 450 L. 1050 L. 1470

LATERAL

GHOST

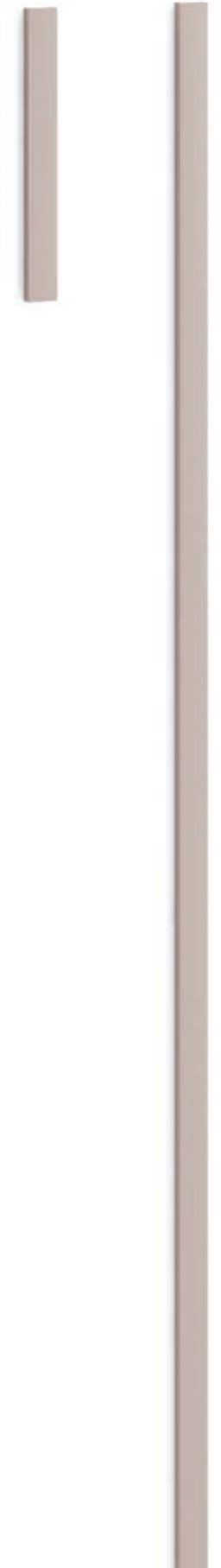



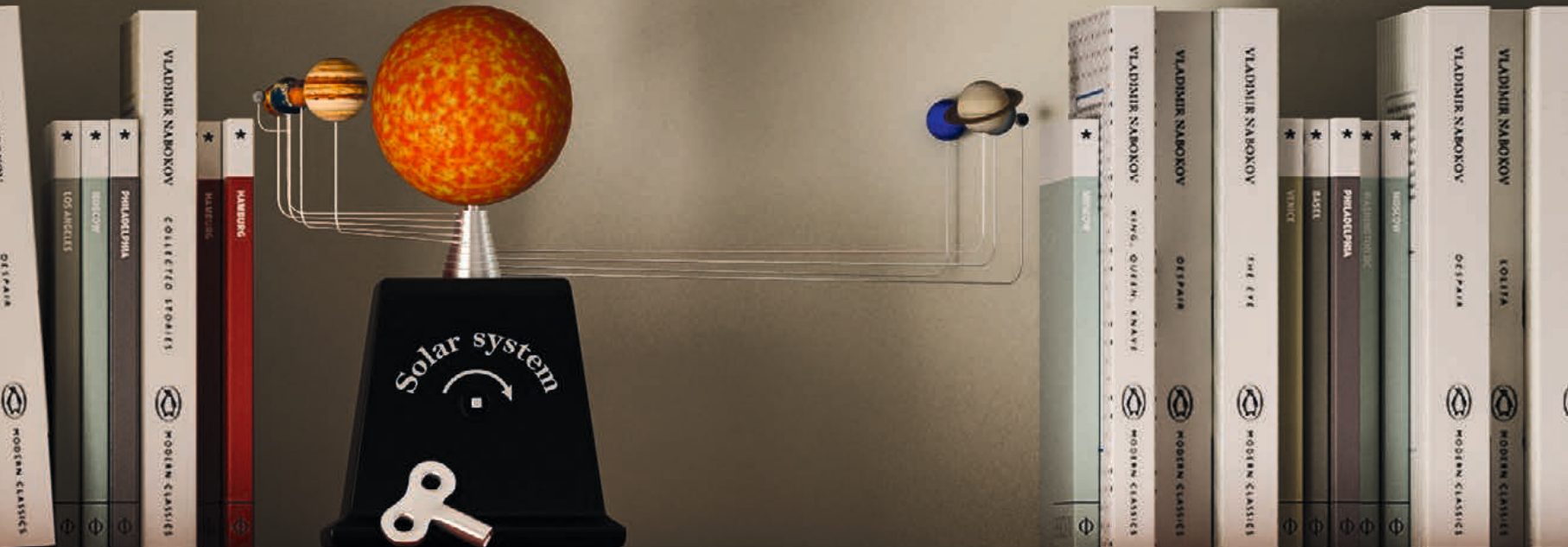

VLADIMIR NABOKOV
КОЛЛЕКЦИЯ
МОДЕРН КЛАСИКСИ

VLADIMIR NABOKOV
ОСІП ПАІА
МОДЕРН КЛАСИКСИ

VLADIMIR NABOKOV
МОСКВА
МОДЕРН КЛАСИКСИ

VLADIMIR NABOKOV
ПРИЛОЖЕННЯ
МОДЕРН КЛАСИКСИ

VLADIMIR NABOKOV
БІСІТ
МОДЕРН КЛАСИКСИ

VLADIMIR NABOKOV
THE LIFE
МОДЕРН КЛАСИКСИ

VLADIMIR NABOKOV
ОСІП ПАІА
МОДЕРН КЛАСИКСИ

VLADIMIR NABOKOV
KING, QUEEN, KNAVE
МОДЕРН КЛАСИКСИ

VLADIMIR NABOKOV
МОСКВА
МОДЕРН КЛАСИКСИ

VLADIMIR NABOKOV
НАВЕРНО
МОДЕРН КЛАСИКСИ

VLADIMIR NABOKOV
КОЛЛЕКЦИЯ СТОРИС
МОДЕРН КЛАСИКСИ

VLADIMIR NABOKOV
ПРИЛОЖЕННЯ
МОДЕРН КЛАСИКСИ

VLADIMIR NABOKOV
МОСКВА
МОДЕРН КЛАСИКСИ

VLADIMIR NABOKOV
LOS ANGELES
МОДЕРН КЛАСИКСИ

VLADIMIR NABOKOV
ОСІП ПАІА
МОДЕРН КЛАСИКСИ



START.20.20

COLORI E MATERIALI
COLORS AND MATERIALS

COLORI E MATERIALI

MELAMINICI DI STRUTTURA

STRUTTURE, SCHIENE, ANTE, FRONTALI, PIANI - 18 / 22 / 30 / 50 MM

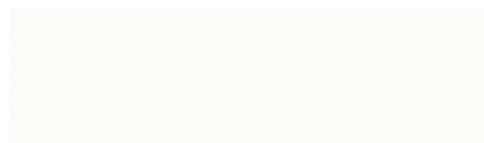

BIANCO



NEVE



OLMO SBIANCATO



OLMO CHIARO



OLMO CENERE

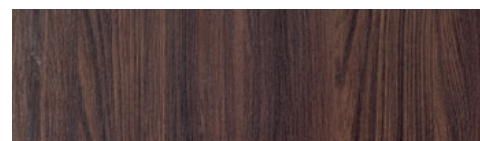

OLMO SCURO

MELAMINICI COLORATI

ANTE, FRONTALI, PIANI, PANNELLI - 18 / 22 / 30 MM

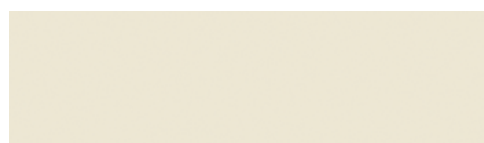

BEIGE



TORTORA



PLATINO



LAVANDA



CIELO



MIMOSA



PAPAVERO

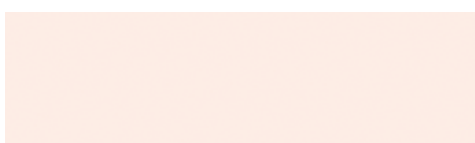

CONFETTO



VERDE

MELAMINICI MATERICI DEKOR

STRUTTURE, ANTE FRONTALI, PIANI, PANNELLI - 18 / 22 / 50 MM



CEMENTO BIANCO

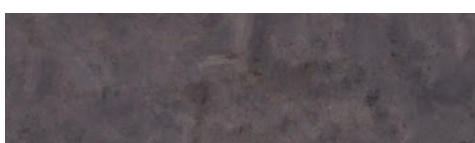

CEMENTO GRIGIO

ESSENZE LEGNO

ANTE, FRONTALI, PANNELLI - 22 / 30 MM



ROVERE 74



NOCE CANALETTO

LACCATI **NEUTRI**



CALCE

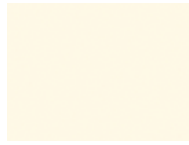

CERA



PANNA



SABBIA



ECRÙ



TERRA



SAHARA



PERLA



TITANIO



ANTRACITE



MOKA



ARDESIA



TUFO



NERO

LACCATI **VIVACI**



CANARINO



AMBRA



OCRA



MANGO



TRAMONTO

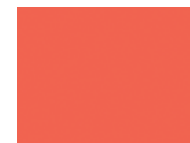

ROSSO



ORIENTE



NINFEA



GLICINE



MELANZANA



VERDE MELA



CEDRO



LIME



GREEN



MIAMI



CELESTE



BALTICO



NOTTE

LACCATI **PASTELLO**

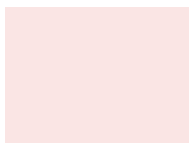

ROSA

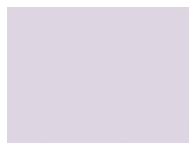

CICLAMINO



ANTICO

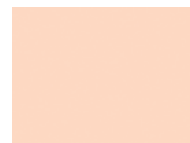

CIPRIA



RAME



MARINA



LAGUNA



MALVA



AVIO



MUSCHIO



MIELE



LIMONE



SKY

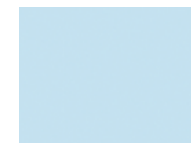

ACQUA



OCEANO

COLORI E MATERIALI

TESSUTI **RALLY**

RIVESTIMENTI TESTIERE, PANNELLI IMBOTTITI, POUF



RALLY TA01



RALLY TA02

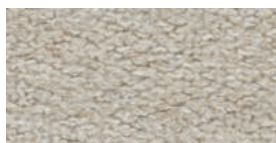

RALLY TA03



RALLY TA04

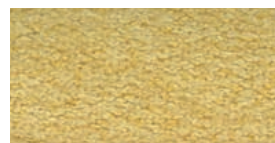

RALLY TA05



RALLY TA06



RALLY TA07



RALLY TA08



RALLY TA09



RALLY TA10



RALLY TA11



RALLY TA12

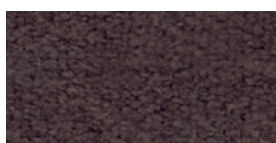

RALLY TA13



RALLY TA14



RALLY TA15

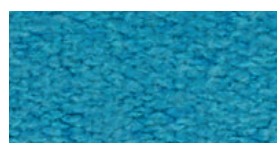

RALLY TA16



RALLY TA17

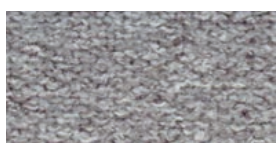

RALLY TA18



RALLY TA19



RALLY TA20

TESSUTI **PIED DE POUL**

RIVESTIMENTI TESTIERE, PANNELLI IMBOTTITI, POUF



PIED DE POUL TA21



PIED DE POUL TA22

TESSUTI **TARTAN**

RIVESTIMENTI TESTIERE, PANNELLI IMBOTTITI, POUF



TARTAN TA23



TARTAN TA24



TARTAN TA25



TARTAN TA26



TARTAN TA27

TESSUTI **MALVASIA**

RIVESTIMENTI TESTIERE, PANNELLI IMBOTTITI, POUF



MALVASIA TB11

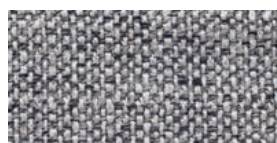

MALVASIA TB12

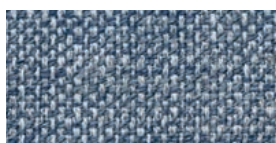

MALVASIA TB13



MALVASIA TB14

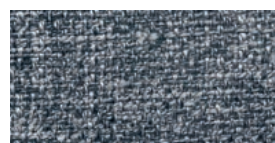

MALVASIA TB15

TESSUTI ALICE

RIVESTIMENTI TESTIERE, PANNELLI IMBOTTITI, POUF



ALICE TA31



ALICE TA32

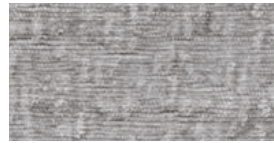

ALICE TA33



ALICE TA34

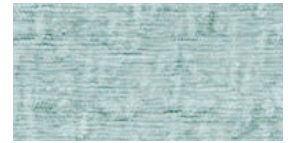

ALICE TA35



ALICE TA36



ALICE TA37



ALICE TA38



ALICE TA39



ALICE TA40

TESSUTI BALOO

RIVESTIMENTI TESTIERE, PANNELLI IMBOTTITI, POUF

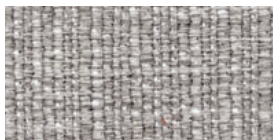

BALOO TA41

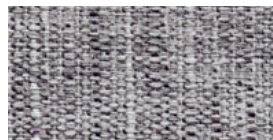

BALOO TA42

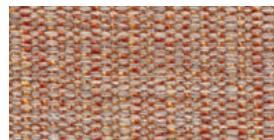

BALOO TA43

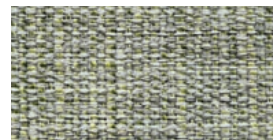

BALOO TA44

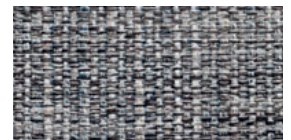

BALOO TA45

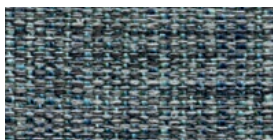

BALOO TA46

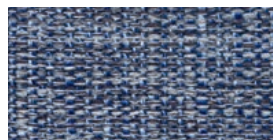

BALOO TA47

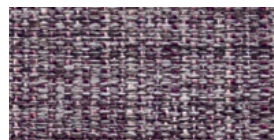

BALOO TA48

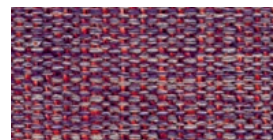

BALOO TA49



BALOO TA50

ECOPELLE

RIVESTIMENTI TESTIERE, PANNELLI IMBOTTITI, POUF

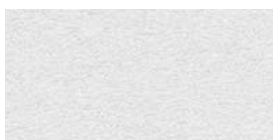

ECOPELLE BIANCO

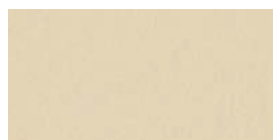

ECOPELLE BEIGE

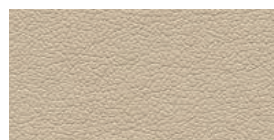

ECOPELLE CANAPA



ECOPELLE GRIGIO MEDIO



ECOPELLE GRIGIO SCURO



ECOPELLE NERO



ECOPELLE MOKA



ECOPELLE BLU



ECOPELLE LILLA



START.20.20

INDICE DELLE COMPOSIZIONI
INDEX OF COMPOSITIONS

COMPOSIZIONI CON LETTI A TERRA

PAG 12



S20_T01

FINITURE / FINISHES:
TORTORA, NOCE CANALETTO, MIELE, TESSUTO TA11

Cabina Naked con ripiani e cassetti.
Letto Cale con testiera imbottita, rete da 900 mm e gambe Kios.
Casellari in metallo Kios.
Scrigno spess. 50 mm. Con gambe Kios.

*Closet Naked with shelves and drawers.
Bed Cale with upholstered headboard, base 900 x 1950 mm on legs Kios.
Metal boxes Kios. Desk th.50 mm on legs Kios.*

PAG 20



S20_T02

FINITURE / FINISHES:
TORTORA, CEMENTO BIANCO, RAME, ANTRACITE

Appendiabiti esterno su panca, Armadio battente con maniglia Sigma C15,
Armadio battente con ante vetro telaio brunito e vetro FUME',
Armadio Duplo, Divano-letto Apollo rete 900, Scrigno spess. 50 mm con gambe
Kios, Base con cassetti, Casellari Kios in metallo brunito

*Wardrobe with glass doors and burnished frame, Fumè glass. Wardrobe Duplo.
Sofa bed Apollo with base 900. Desk th.50 mm with legs Kios in burnished metal.
Box base with drawers. Boxes Kios in burnished metal.*

PAG 28



S20_T03

FINITURE / FINISHES:
NEVE, TERRA, MALVA, NOCE CANALETTO

Armadio battente con maniglia Stripe.
Cabina Flexy senza schiena con ripiani e settimanile.
Letto Fresh rete 1200.
Basi a terra con cassetti e casellari in metallo Kios a muro.
Mensole Star.

*Wardrobe with handle Stripe. Cabine Flexy without back with shelves and
chest of drawers. Bed Fresh with base 1200. Floorstanding boxes with
drawers and Kios metal boxes resting on. Shelves Star.*

PAG 40



S20_T04

FINITURE / FINISHES:
OLMO CENERE, TORTORA, TERRA, AVIO, TESSUTO TA12-TA13

Armadio battente e Ponte Autoportante con maniglia Ghost.
Cabina Naked brunita con ripiani e cassettiere appese.
Letto XL con pannellatura Cloud.
Scrigno spess. 50 mm con gamba Kios brunita.
Casellari in metallo Kios.

*Wardrobe with handle Ghost. Self-supporting bridge with handle Ghost.
Cabin Naked burnished with shelves and hanging chest of drawers.
Bed XL with panels Cloud. Desk th. 50 mm with burnished leg Kios metal
boxes Kios.*

COMPOSIZIONI CON LETTI A TERRA

PAG 50



S20_T05

FINITURE / FINISHES:
OLMO CHIARO, TORTORA, CICLAMINO, ANTICO, TESSUTO TA14-TA03

Armadio battente Maxi con maniglia Stripe.
Libreria terminale con scrittoio a ribalta.
Letto XL con pannellatura imbottita Cloud. Mensole Star.
Settimanile su panca con appendiabiti in metallo.

Wardrobe with hinged door Maxi with handle Stripe and terminal bookcase and flap desk. Bed XL with padded panels Cloud. Shelves Star. Chest of drawers on bench with metal clothes rack Ambrogio.

PAG 58

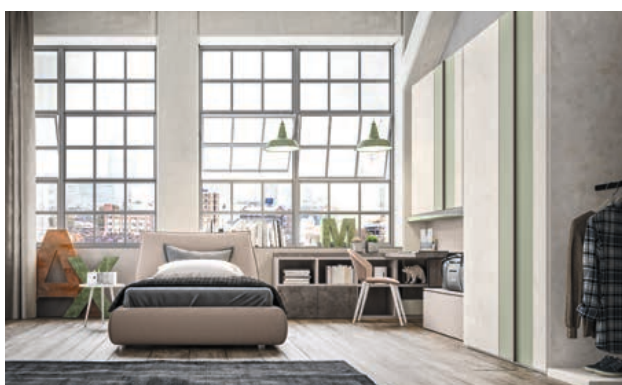

S20_T06

FINITURE / FINISHES:
PLATINO, CEMENTO BIANCO, CEMENTO GRIGIO, LAGUNA, TESSUTO TA12

Armadio battente con anta Stripe bicolor.
Ponte autoportante con ante Stripe bicolor.
Scrittoio spess. 50 mm In appoggio a libreria spalla e base a terra.
Letto Doll imbottito rete 1200.

Wardrobe with door Stripe bicolored. Self-supporting bridge with doors Stripe bicolored. Desk th.50 mm resting on a library and floorstanding box base. Upholstered Doll bed for base 1200 mm.

PAG 66



S20_T07

FINITURE / FINISHES:
OLMO SCURO, PLATINO, LAGUNA, MALVA, TESSUTO TB15

Armadio battente con maniglia Stripe, armadio con vano a giorno, specchio e appendiabiti, libreria terminale.
Letto Slitta imbottito con rete 1200.
Scrittoio spess. 50 mm con gamba Slitta.
Pensili apertura ribalta con casellari Fedra.

Wardrobe with hinged doors, handle Stripe, wardrobe with open space, mirror and hanging rods. Terminal bookcase. Upholstered bed Slitta with base w. 1200. Desk th. 50 mm with leg Slitta. Boxes with flap opening and boxes Fedra.

PAG 74



S20_T08

FINITURE / FINISHES:
OLMO CHIARO, PERLA, CIELO

Armadio scorrevole Duo.
Letto Terry con rete 900.
Basi a terra uso comodino con maniglia C03.
Pensili apertura a ribalta e battente, raccordati da mensola Star.
Scrittoio sp. 50 mm con fianco sp. 50 mm.

Wardrobe with sliding doors Duo. Bed Terry with base w. 900. Floorstanding boxes for nightstand use with handle C03. Hanging boxes with flap and hinged opening, connected with shelf Star.

COMPOSIZIONI CON LETTI A TERRA

PAG 84



S20_T09

FINITURE / FINISHES:
OLMO SBIANCATO, BEIGE, ANTICO, OCEANO

Armadio battente con anta Slim Ghost.
Ponte autoportante con anta Slim Ghost.
Letto Arche' con ruote, rete da 900.
Scrivania e panca in spess. 50 mm.
Libreria Gate H. 368 mm.

*Wardrobe with hinged doors Slim Ghost.
Self-supporting bridge with door Slim Ghost.
Bed Archè on wheels with base 900. Desk and bench th. 50 mm.
Bookcase Gate h.368 mm.*

PAG 92



S20_T10

FINITURE / FINISHES:
NEVE, TORTORA, VERDE, MUSCHIO, TESSUTO TB02

Cabina Angolo Lite con maniglia C05 brunita.
Letto Karta con testiera imbottita Tessuto TB02.
Mensole Snake. Scrivania sospesa spess. 50 mm.
Libreria Gate H. 1104-368.
Cassettiera su ruote con maniglia C04 brunita.

*Corner cabinet Lite with burnished handle C05.
Bed Karta with upholstered headboard TB02 fabric.
Shelves Snake suspended desk th. 50 mm.
Library Gate h. 1104-368.
Chest of drawers on wheels with burnished handle C04.*

PAG 100



S20_T11

FINITURE / FINISHES:
OLMO CENERE, TORTORA, OCRA

Terminale libreria. Armadio battente con maniglia C11.
Ponte autoportante Blok.
Scrivania scorrevole spess. 30 mm con gambe Diapason.
Panca con cassettiera in appoggio.
Letto Karta scorrevole.

*Open end unit. Wardrobe with handle C11.
Overhead unit Blok.
Sliding desk th.30 mm with legs Diapason.
Bench with chest of drawers overlapped.
Sliding bed Karta.*

PAG 112



S20_T12

FINITURE / FINISHES:
PLATINO, CEMENTO GRIGIO, AVIO, ANTRACITE, TESSUTO TB15

Armadio battente con maniglia Lateral e libreria terminale.
Sistema letto Wall, con giroletto rete 900 e piedini Lateral.
Scrivania sospesa sp. 50 mm. con pensili.

*Wardrobe with hinged doors handle lateral and terminal bookcase.
Bed system Wall, ring for base 900 and metal feet.
Hanging desk with boxes.*

COMPOSIZIONI CON LETTI A TERRA

PAG 118



S20_T13

FINITURE / FINISHES:
PLATINO, CEMENTO GRIGIO, PERLA, LAGUNA, TESSUTO TB11 E TB15

Sistema letto Wall, con giroletto rete 900 e piedino in metallo Kios.
Tavolino tripode. Pensile con cassetto. Mensole Snake.
Armadio battente con maniglie Ghost.

*Bed system Wall, ring for base 900 and metal feet Kios
Table Tripode, hanging box with drawer.
Shelves Snake wardrobe with handles Ghost.*

PAG 126

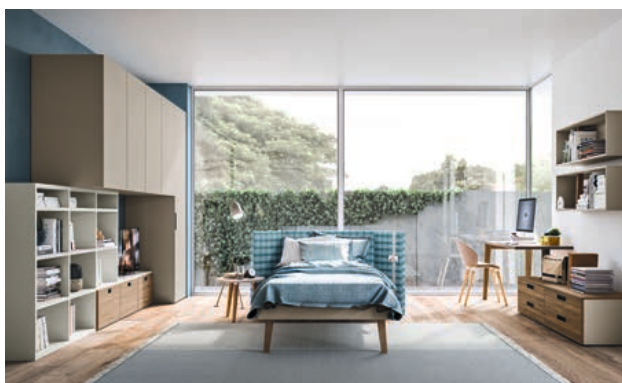

S20_T14

FINITURE / FINISHES:
TORTORA, PERLA, NOCE CANALETTO, TESSUTO TA27

Armadio battente con maniglia incasso C17.
Ponte autoportante in appoggio a libreria spalla a giorno e cassettoni.
Letto Sipario con gambe in legno. Tavolino Tripode.
Basi a terra con cassetti e maniglia C16. Casellari Wood Case.
Scrivania spess. 30 mm bicolore con gamba Wood Bridge in legno.

*Wardrobe with hinged doors handle C17.
Overhead unit overlapped on a bookcase and drawers.
Bed Sipario with wooden legs. Table Tripode.
Floorstanding boxes with drawers handle C16. Boxes Wood Case.
Desk th.30 mm bicolored with leg Wood Bridge.*

PAG 134



S20_T15

FINITURE / FINISHES:
TORTORA, MIELE, ROVERE 74, TESSUTO TA26

Armadio battente con anta Slim e maniglia Lateral.
Elemento terminale a giorno con appendiabiti.
Letto Sipario con gambe in legno. Base a terra con cassetto e libreria Gate in appoggio H. 1104 mm. Scrivania spess. 30 mm con gamba Wood Bridge in legno.
Tavolino Tripode.

*Wardrobe with hinged door Slim and handle Lateral.
Open space terminal with clothes hanger. Bed Sipario with wooden legs.
Floorstanding box with drawer and overlapped bookcase h. 1104 mm.
Desk th.30 mm with Wood Bridge leg. Table Tripode.*



PAG 144



S20_P16

FINITURE / FINISHES:
OLMO CENERE, TORTORA, LAGUNA, MUSCHIO

Armadio battente con maniglia C07.
Ponte autoportante Blok. Libreria Gate H.368-1104.
Letto Tonga rete da 900. Base con cassettoni.
Scrivania spess. 30 mm bicolore con gamba Slim.

*Wardrobe with handle C07. Overhead unit Blok.
Library Gate H.368-1104. Bed Tonga for base 900.
Box base with drawer.
Desk th. 30 mm. Bicolored with leg Slim.*

PAG 150



S20_P17

FINITURE / FINISHES:
LAVANDA, CIELO, CEMENTO BIANCO, TORTORA, TESSUTO TA36-TA37

Armadio laterale con specchio e attrezzato di ripiani e tubo appendiabiti.
Armadio battente con maniglia C05 brunita. Ponte autoportante Blok.
Giroletto Turca rete 900. Pannellatura Cloud in Tessuto TA36-TA37.
Cassettiera con maniglia C04 brunita.
Libreria Gate H.1104 con scrivania spess. 50 mm gamba Charme.

*Lateral wardrobe with mirror and equipped with shelves and hanging rods.
Wardrobe with handle C05 burnished. Self supporting bridge Blok.
Bed ring for base 900. Panelling Cloud TA36-TA37 fabric.
Chest of drawers with handle C04 burnished.
Library Gate H. 1104 with desk th. 50 mm. Leg Charme.*

PAG 158



S20_P18

FINITURE / FINISHES:
NEVE, BEIGE, VERDE, MARINA, TESSUTO TA16-TA21

Armadio laterale attrezzato di ripiani e tubo appendiabiti.
Armadio battente con maniglia Stripe. Ponte autoportante Blok
con maniglie Stripe. Scrivania spess. 30 mm con fianco libreria.
Pensile con cassetto uso comodino. Giroletto turca rete 900.
Pannellatura Cloud in Tessuto TA16-TA21. Mensole con schiena.

*Lateral wardrobe equipped with shelves and hanging rods.
Wardrobe with handle Stripe. Self supporting bridge Blok with handles Stripe.
Desk th. 50 mm with side bookcase. Hanging box with drawer for nightstand use.
Bed ring for base 900. Panelling Cloud TA16-TA21 fabric. Shelves with back.*

PAG 168



S20_P19

FINITURE / FINISHES:
TORTORA, NOCE CANALETTO, MIELE, TESSUTO TA11

Armadio battente on maniglia Ghost. Ponte autoportante con maniglia Ghost.
Letto XL con libreria di raccordo sotto ponte.
Scrivania spess. 50 mm con gamba Quadro laccata.
Libreria Gate H.368 mm.

*Wardrobe with handle Ghost. Self-supporting bridge with handle Ghost.
Bed XL with bookcase under the bridge.
Desk th.50 mm with lacquered leg Quadro.
Bookcase Gate h. 368 mm.*

COMPOSIZIONI A PONTE

PAG 174



S20_P20

FINITURE / FINISHES:
TORTORA, OLMO SCURO, MIELE

Armadio battente con maniglia Lateral.
Ponte autoportante Blok con maniglie Lateral.
Letti XL ad angolo.
Scrivania spess. 50 mm con gambe Slim.

*Wardrobe with handle Lateral.
Self supporting bridge Blok with handle Lateral.
Corner beds XL.
Desk th.50 mm with legs Slim.*

PAG 182



S20_P21

FINITURE / FINISHES:
TORTORA, NEVE, PAPAVERO, CICLAMINO

Armadio battente con maniglia Stripe.
Ponte a terra con maniglie Stripe e fianchi a "C".
Letti Lobby basso ed estraibile con cassettoni.
Scrivania spess. 30 mm scorrevole.

*Wardrobe with handle Stripe,
floorstanding bridge with handle Stripe and "C".
Sides lower beds Lobby and pull out drawers;
sliding desk th. 30 mm.*

PAG 186



S20_P22

FINITURE / FINISHES:
OLMO CHIARO, NEVE, PERLA, MIELE

Ponte a terra con fianco a "C". Armadio battente con maniglia C03.
Armadio corner battente con maniglia C03.
Letto Puzzle con giroletto pianale e gamba Slitta. Casellari Cross.
Scrivania spess. 50 mm Con gamba Slitta in appoggio a base a terra con cassetti.

*Corner wardrobe with handle C03;
wardrobe with hinged door handle C03;
floorstanding bridge with side "C".
Bed Puzzle with wooden platform and leg Slitta. Boxes Cross.
Desk th. 50 mm. with leg Slitta overlapped on a box base with drawers.*

PAG 192



S20_P23

FINITURE / FINISHES:
OLMO SBIANCATO, BEIGE, AVIO, MUSCHIO, TESSUTO TA46

Armadio battente con maniglia C11.
Ponte a terra ad angolo con fianco libreria.
Letto imbottito Botton rete 900.
Scrivania spess. 30 mm con elemento retro letto estraibile.

*Wardrobe with handle C11.
Floorstanding corner bridge with library side.
Upholstered bed Botton for base 900.
Desk th.30 mm with pull out bed back item.*

PAG 200



S20_P24

FINITURE / FINISHES:
NEVE, PLATINO, CEMENTO GRIGIO, AVIO

Armadio Maxi con maniglia C17 cromo.
Ponte a terra Store.
Armadio battente con cassetti e maniglie C17-C16 cromo.
Letto Lobby estraibile con cassettoni.

*Maxi wardrobe with C17 chrome handle,
Store floor bridge, wardrobe with drawers and handles C17-C16 chrome;
Extractable pull-out bed with drawers.*

PAG 206



S20_P25

FINITURE / FINISHES:
NEVE, TORTORA, OCEANO, LAVANDA, TESSUTO TA36-TA39

Cabina angolo Lite con maniglia C22. Libreria terminale.
Ponte autoportante Blok.
Sistema letto Wall, letto Lobby estraibile con cassettoni.
Mensola Snake.
Scrittoio spess. 50 mm con fianco spess. 50 mm.

*Corner cabinet Lite with handle C22.
Terminal library self supporting bridge Blok.
Bed system Wall, pull out bed Lobby with drawers.
Shelf Snake desk th.50 mm. With side th. 50 mm.*

PAG 214



S20_P26

FINITURE / FINISHES:
OLMO CHIARO, PAPAVERO, CICLAMINO, BEIGE

Armadio battente con maniglia Stripe.
Ponte autoportante Blok con maniglie Stripe.
Letto Lobby corner, con letto Lobby estraibile.
Libreria Gate H.368.

*Wardrobe with handle Stripe.
Self supporting bridge Blok with handles Stripe.
Corner bed Lobby, with pull-out bed Lobby.
Library Gate h. 368.*

PAG 224



S20_P27

FINITURE / FINISHES:
OLMO SCURO, TORTORA, AVIO, VETRO FUMÉ, TESSUTO TA47

Appendiabiti esterno su panca. Armadio battente e cassetti con maniglie C16-C17 brunito. Armadio Duplo. Divano-letto Less con Tessuto TA47.
Ponte autoportante Blok con ante vetro telaio brunito e vetro fumé.
Libreria a spalla sottoponte con scrittoio spess. 30 mm e gamba Kios in metallo brunito.

*External hanging clothes on bench. Wardrobe with hinged doors and drawers with handles C16-C17 burnished. Wardrobe Duplo. Sofa bed Apollo.
Self supporting bridge Blok with glass doors burnished frame, fumè glass.
Library under the bridge with desk th.30 mm and leg Kios metal burnished.*

COMPOSIZIONI SALVASPAZIO

PAG 232



S20_S28

FINITURE / FINISHES:
TORTORA, CEMENTO BIANCO, MALVA, CEDRO

Letto Soppalco Slide con letto inferiore Lobby estraibile.
Armadio scorrevole Puzzle.
Scrivania spess. 50 mm con gambe Slitta.

*Loft bed Slide with pull out lower bed Lobby.
Wardrobe with sliding doors Puzzle.
Desk 50 mm thick with Slitta legs.*

PAG 242



S20_S29

FINITURE / FINISHES:
OLMO CHIARO, BEIGE, LAVANDA, OCEANO, TESSUTO TA33

Armadio Maxi con maniglia C11.
Letto Soppalco-ponte lineare con protezione Dama imbottita Tessuto TA33.
Letto inferiore Lobby estraibile con cassettoni.

*Wardrobe Maxi with handle C11.
Bed linear Loft-bridge with protection Dama upholstered Fabric TA33.
Pull out lower bed Lobby with drawers.*

PAG 252



S20_S30

FINITURE / FINISHES:
NEVE, TORTORA, CONFETTO, ANTICO

Armadio battente con ante Slim e maniglia C22.
Letto Soppalco 90° ponte, con protezione Dama e salita posteriore.
Letto polifunzionale Nikai inferiore.
Base a terra con cassettoni.

*Hinged wardrobe with doors Slim and handle C22.
Loft bed 90° bridge, with protection Dama and rear climb.
Lower multifunctional bed Nikai.
Base box with drawer.*

PAG 260



S20_S31

FINITURE / FINISHES:
OLMO SBIANCATO, BEIGE, MIMOSA, MALVA

Armadio battente con ante Stripe bicolor.
Letto Soppalco scorrevole.
Giroletto turca inferiore.
Scrivania sospesa spess. 50 mm.
Casellario Trigo, pensile a ribalta, casellari Case.

*Hinged wardrobe with door Stripe bicolored.
Sliding loft bed. Lower bed frame.
Suspended desk 50 mm thick.
Wallbox Trigo, box with flap door, wallboxes Case.*

PAG 270



S20_S32

FINITURE / FINISHES:
OLMO SBIANCATO, TORTORA, AVIO, MARINA

Armadio battente con maniglia Ghost.
Cabina Naked brunita con ripiani e tubi appendiabiti.
Letto castello Sky con scaletta in metallo frontale.
Letto inferiore Tex con piedini Kios in metallo.
Scrigno spess. 50 mm con fianco spess. 50 mm. Casellari Cross.

*Hinged wardrobe with doors Olmo sbiancato and drawers lacquered Avio and Marina; handles Ghost lacquered Avio and Marina.
Burnished cabinet Naked with shelves Olmo Sbiancato and burnished coat hangers with antislip rubber.*

PAG 278



S20_S33

FINITURE / FINISHES:
NEVE, TORTORA, CIELO, MARINA

Libreria terminale. Armadio battente con maniglia C03.
Cabina armadio con maniglia C03.
Letto castello Sky con scaletta in metallo frontale e
scrigno con gamba Charme.

*Terminal bookcase. Hinged wardrobe with handle C03.
Cabinet with handle C03.
Bunk bed Sky with ladder with metal front and
desk with leg Charme.*

PAG 286



S20_S34

FINITURE / FINISHES:
OLMO CENERE, TORTORA, MIMOSA, CICLAMINO

Letto castello a sbalzo con scaletta in metallo.
Letto inferiore XL con fianco libreria.
Scrigno spess. 50 mm con gambe Quadro.
Armadio battente e cassetti con maniglie Lateral.
Cabina Flexy con ripiani e tubi appendiabiti.

*Bunk bed with metallic ladder. Lower bed XL with bookcase side.
Desk 50 mm thick with Quadro legs.
Hinged wardrobe and drawers with handles Lateral
Cabinet Flexy with shelves and coat hangers.*

PAG 294



S20_S35

FINITURE / FINISHES:
OLMO SBIANCATO, TORTORA, CIELO

Armadio battente con maniglie Stripe.
Letto Sky con camminata e protezioni Dama imbottite
in Tessuto TA16 e TA17.
Giroletto turca Smart imbottita in Tessuto TA17.

*Hinged wardrobe with handle Stripe.
Bed Sky with rear walking and protections Dama upholstered
with Fabric TA16 and TA17.
Bedframe Smart upholstered with Fabric TA17.*

HOMES

UN GRUPPO, MOLTE RISPOSTE



AZIENDE DEL GRUPPO HOMES

CLEVER
MISTRAL
ORME
SAN MICHELE
NARDIINTERNI

CLEVER

Homes Casa S.p.a.
Via E. Majorana, 186
31053 Pieve di Soligo (TV) Italy
Tel. +39 0438 909011 - Fax +39 0438 909090
clever@homes.it - www.clever.it

Export Department
Tel. +39 0438 839832 - Fax +39 0438 839859
export@homes.it - www.homes.it

Homes S.p.a. - Headquarters
Via Montello 63/1
31053 Pieve di Soligo (TV) Italy
Tel. +39 0438 909081 - Fax +39 0438 909089
info@homes.it - www.homes.it

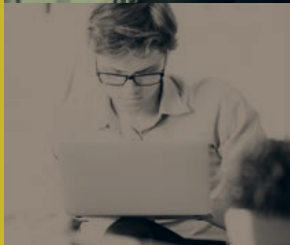

CLEVER



www.clever.it



C3X00140